

# Surgical Saw Blades

## CATALOGUE

Accessible and Reliable

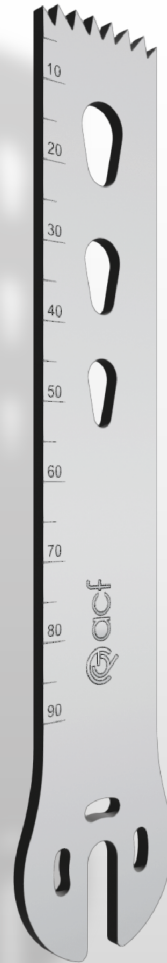



**Saw Blades  
Compatible with  
ACF<sup>®</sup>**



Brand Code **360**

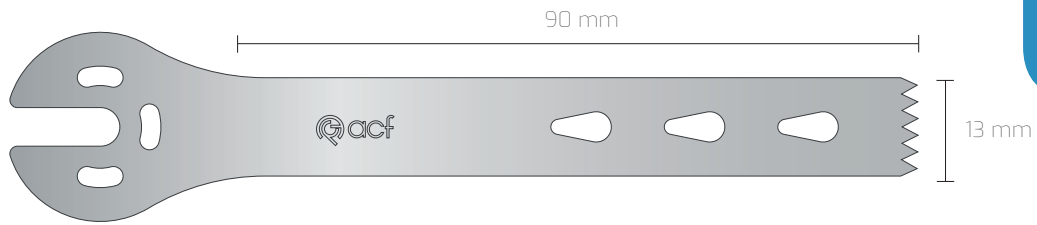

NON-STERILE REF	STERILE REF	Cutting Edge	Cutting Depth	Material Thickness	Cutting Thickness	Teeth
360 130 090 089	S 360 130 090 089	13 mm	90 mm	0,89 mm	0,89 mm	Straight
360 130 090 090	S 360 130 090 090	13 mm	90 mm	0,90 mm	0,90 mm	Straight
360 130 090 100	S 360 130 090 100	13 mm	90 mm	1,00 mm	1,00 mm	Straight
360 130 090 119	S 360 130 090 119	13 mm	90 mm	1,19 mm	1,19 mm	Straight
360 130 090 120	S 360 130 090 120	13 mm	90 mm	1,20 mm	1,20 mm	Straight
360 130 090 127	S 360 130 090 127	13 mm	90 mm	1,27 mm	1,27 mm	Straight
360 130 090 130	S 360 130 090 130	13 mm	90 mm	1,30 mm	1,30 mm	Straight
360 130 090 137	S 360 130 090 137	13 mm	90 mm	1,37 mm	1,37 mm	Straight
360 130 090 140	S 360 130 090 140	13 mm	90 mm	1,40 mm	1,40 mm	Straight
360 130 090 147	S 360 130 090 147	13 mm	90 mm	1,47 mm	1,47 mm	Straight
360 130 090 150	S 360 130 090 150	13 mm	90 mm	1,50 mm	1,50 mm	Straight

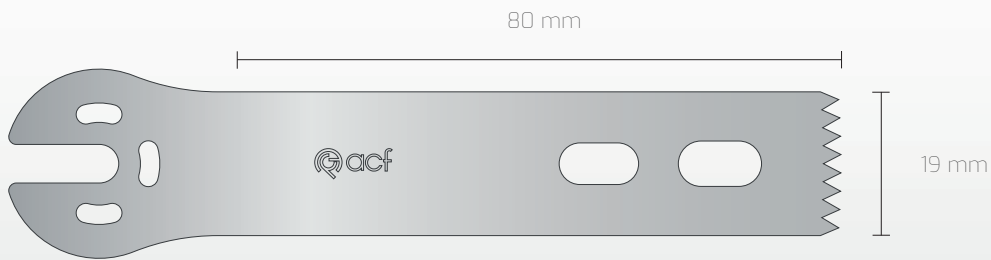

NON-STERILE REF	STERILE REF	Cutting Edge	Cutting Depth	Material Thickness	Cutting Thickness	Teeth
360 190 080 090	S 360 190 080 090	19 mm	80 mm	0,90 mm	0,90 mm	Straight
360 190 080 100	S 360 190 080 100	19 mm	80 mm	1,00 mm	1,00 mm	Straight
360 190 080 120	S 360 190 080 120	19 mm	80 mm	1,20 mm	1,20 mm	Straight

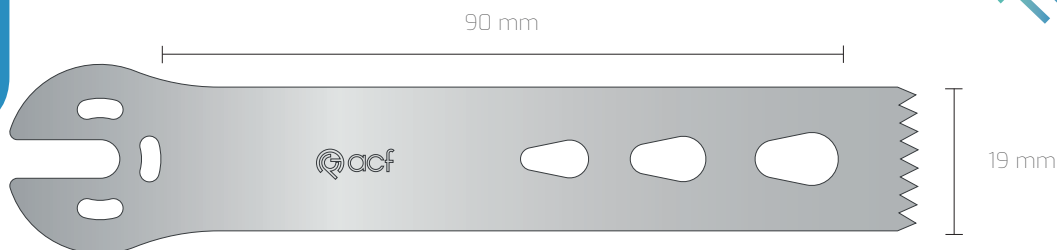

NON-STERILE REF	STERILE REF	Cutting Edge	Cutting Depth	Material Thickness	Cutting Thickness	Teeth
360 190 090 089	S 360 190 090 089	19 mm	90 mm	0,89 mm	0,89 mm	Straight
360 190 090 090	S 360 190 090 090	19 mm	90 mm	0,90 mm	0,90 mm	Straight
360 190 090 100	S 360 190 090 100	19 mm	90 mm	1,00 mm	1,00 mm	Straight
360 190 090 119	S 360 190 090 119	19 mm	90 mm	1,19 mm	1,19 mm	Straight
360 190 090 120	S 360 190 090 120	19 mm	90 mm	1,20 mm	1,20 mm	Straight
360 190 090 127	S 360 190 090 127	19 mm	90 mm	1,27 mm	1,27 mm	Straight
360 190 090 130	S 360 190 090 130	19 mm	90 mm	1,30 mm	1,30 mm	Straight
360 190 090 137	S 360 190 090 137	19 mm	90 mm	1,37 mm	1,37 mm	Straight
360 190 090 140	S 360 190 090 140	19 mm	90 mm	1,40 mm	1,40 mm	Straight
360 190 090 147	S 360 190 090 147	19 mm	90 mm	1,47 mm	1,47 mm	Straight
360 190 090 150	S 360 190 090 150	19 mm	90 mm	1,50 mm	1,50 mm	Straight

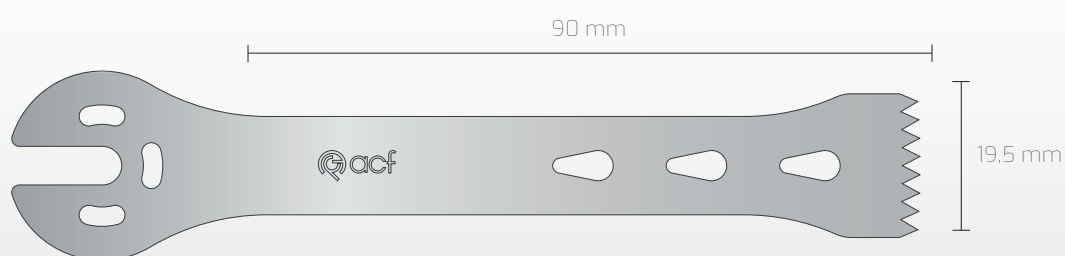

NON-STERILE REF	STERILE REF	Cutting Edge	Cutting Depth	Material Thickness	Cutting Thickness	Teeth
360 195 090 089	S 360 195 090 089	19,5 mm	90 mm	0,89 mm	0,89 mm	Straight
360 195 090 090	S 360 195 090 090	19,5 mm	90 mm	0,90 mm	0,90 mm	Straight
360 195 090 100	S 360 195 090 100	19,5 mm	90 mm	1,00 mm	1,00 mm	Straight
360 195 090 119	S 360 195 090 119	19,5 mm	90 mm	1,19 mm	1,19 mm	Straight
360 195 090 120	S 360 195 090 120	19,5 mm	90 mm	1,20 mm	1,20 mm	Straight
360 195 090 127	S 360 195 090 127	19,5 mm	90 mm	1,27 mm	1,27 mm	Straight
360 195 090 130	S 360 195 090 130	19,5 mm	90 mm	1,30 mm	1,30 mm	Straight
360 195 090 137	S 360 195 090 137	19,5 mm	90 mm	1,37 mm	1,37 mm	Straight
360 195 090 140	S 360 195 090 140	19,5 mm	90 mm	1,40 mm	1,40 mm	Straight
360 195 090 147	S 360 195 090 147	19,5 mm	90 mm	1,47 mm	1,47 mm	Straight
360 195 090 150	S 360 195 090 150	19,5 mm	90 mm	1,50 mm	1,50 mm	Straight

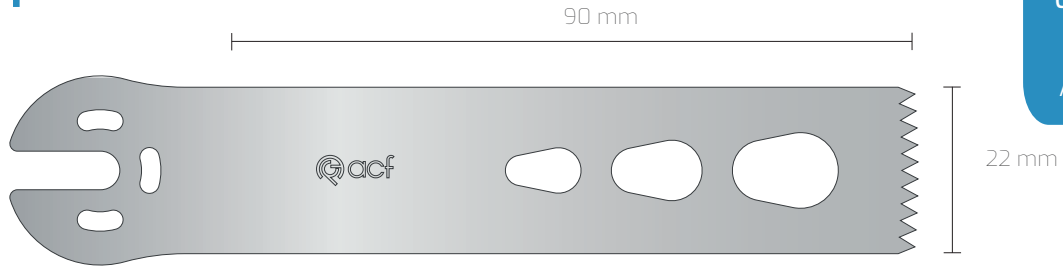

NON-STERILE REF	STERILE REF	Cutting Edge	Cutting Depth	Material Thickness	Cutting Thickness	Teeth
360 220 090 089	S 360 220 090 089	22 mm	90 mm	0,89 mm	0,89 mm	Straight
360 220 090 090	S 360 220 090 090	22 mm	90 mm	0,90 mm	0,90 mm	Straight
360 220 090 100	S 360 220 090 100	22 mm	90 mm	1,00 mm	1,00 mm	Straight
360 220 090 119	S 360 220 090 119	22 mm	90 mm	1,19 mm	1,19 mm	Straight
360 220 090 120	S 360 220 090 120	22 mm	90 mm	1,20 mm	1,20 mm	Straight
360 220 090 127	S 360 220 090 127	22 mm	90 mm	1,27 mm	1,27 mm	Straight
360 220 090 130	S 360 220 090 130	22 mm	90 mm	1,30 mm	1,30 mm	Straight
360 220 090 137	S 360 220 090 137	22 mm	90 mm	1,37 mm	1,37 mm	Straight
360 220 090 140	S 360 220 090 140	22 mm	90 mm	1,40 mm	1,40 mm	Straight
360 220 090 147	S 360 220 090 147	22 mm	90 mm	1,47 mm	1,47 mm	Straight
360 220 090 150	S 360 220 090 150	22 mm	90 mm	1,50 mm	1,50 mm	Straight

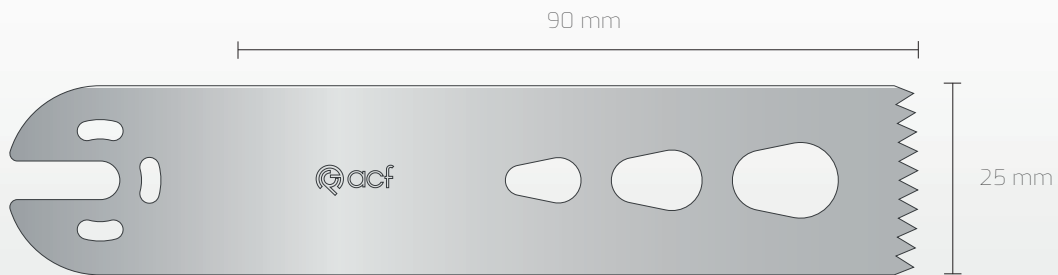

NON-STERILE REF	STERILE REF	Cutting Edge	Cutting Depth	Material Thickness	Cutting Thickness	Teeth
360 250 090 089	S 360 250 090 089	25 mm	90 mm	0,89 mm	0,89 mm	Straight
360 250 090 090	S 360 250 090 090	25 mm	90 mm	0,90 mm	0,90 mm	Straight
360 250 090 100	S 360 250 090 100	25 mm	90 mm	1,00 mm	1,00 mm	Straight
360 250 090 119	S 360 250 090 119	25 mm	90 mm	1,19 mm	1,19 mm	Straight
360 250 090 120	S 360 250 090 120	25 mm	90 mm	1,20 mm	1,20 mm	Straight
360 250 090 127	S 360 250 090 127	25 mm	90 mm	1,27 mm	1,27 mm	Straight
360 250 090 130	S 360 250 090 130	25 mm	90 mm	1,30 mm	1,30 mm	Straight
360 250 090 137	S 360 250 090 137	25 mm	90 mm	1,37 mm	1,37 mm	Straight
360 250 090 140	S 360 250 090 140	25 mm	90 mm	1,40 mm	1,40 mm	Straight
360 250 090 147	S 360 250 090 147	25 mm	90 mm	1,47 mm	1,47 mm	Straight
360 250 090 150	S 360 250 090 150	25 mm	90 mm	1,50 mm	1,50 mm	Straight

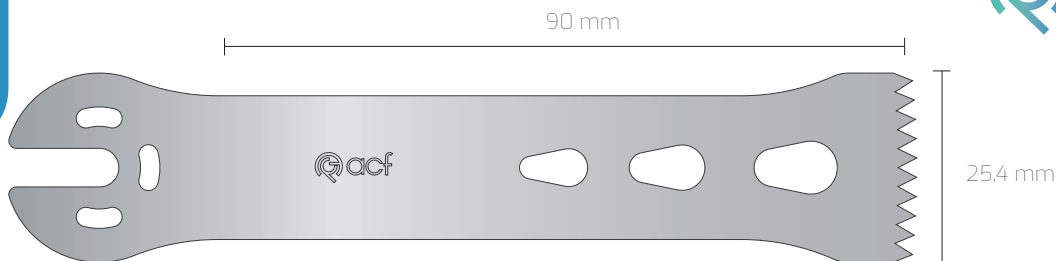

NON-STERILE REF	STERILE REF	Cutting Edge	Cutting Depth	Material Thickness	Cutting Thickness	Teeth
360 254 090 089	S 360 254 090 089	25,4 mm	90 mm	0,89 mm	0,89 mm	Straight
360 254 090 090	S 360 254 090 090	25,4 mm	90 mm	0,90 mm	0,90 mm	Straight
360 254 090 100	S 360 254 090 100	25,4 mm	90 mm	1,00 mm	1,00 mm	Straight
360 254 090 119	S 360 254 090 119	25,4 mm	90 mm	1,19 mm	1,19 mm	Straight
360 254 090 120	S 360 254 090 120	25,4 mm	90 mm	1,20 mm	1,20 mm	Straight
360 254 090 127	S 360 254 090 127	25,4 mm	90 mm	1,27 mm	1,27 mm	Straight
360 254 090 130	S 360 254 090 130	25,4 mm	90 mm	1,30 mm	1,30 mm	Straight
360 254 090 137	S 360 254 090 137	25,4 mm	90 mm	1,37 mm	1,37 mm	Straight
360 254 090 140	S 360 254 090 140	25,4 mm	90 mm	1,40 mm	1,40 mm	Straight
360 254 090 147	S 360 254 090 147	25,4 mm	90 mm	1,47 mm	1,47 mm	Straight
360 254 090 150	S 360 254 090 150	25,4 mm	90 mm	1,50 mm	1,50 mm	Straight

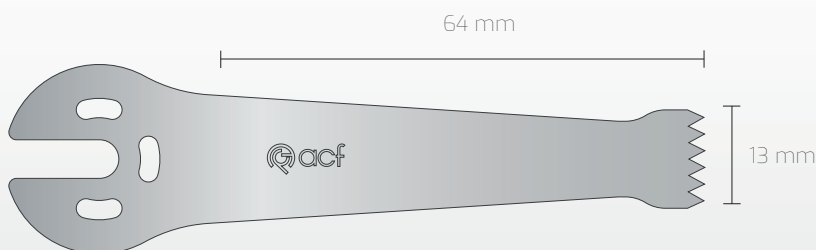

NON-STERILE REF	STERILE REF	Cutting Edge	Cutting Depth	Material Thickness	Cutting Thickness	Teeth
360 130 064 090	S 360 130 064 090	13 mm	64 mm	0,90 mm	0,90 mm	Straight

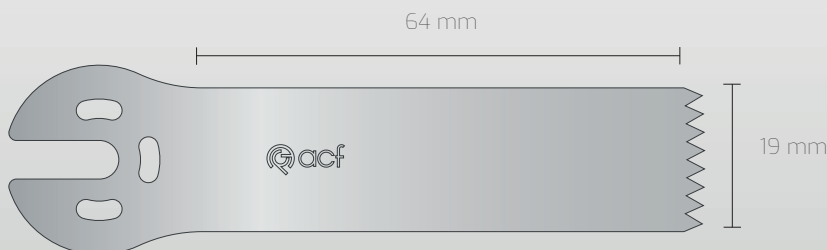

NON-STERILE REF	STERILE REF	Cutting Edge	Cutting Depth	Material Thickness	Cutting Thickness	Teeth
360 190 064 090	S 360 190 064 090	19 mm	64 mm	0,90 mm	0,90 mm	Straight

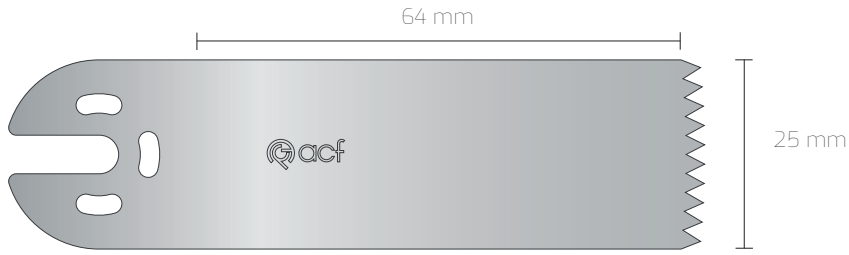

NON-STERILE REF	STERILE REF	Cutting Edge	Cutting Depth	Material Thickness	Cutting Thickness	Teeth
360 250 064 090	5 360 250 064 090	25 mm	64 mm	0,90 mm	0,90 mm	Straight

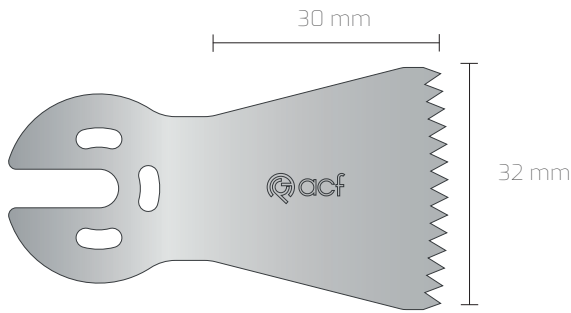

NON-STERILE REF	STERILE REF	Cutting Edge	Cutting Depth	Material Thickness	Cutting Thickness	Teeth
360 320 030 090	5 360 320 030 090	32 mm	30 mm	0,90 mm	0,90 mm	Straight

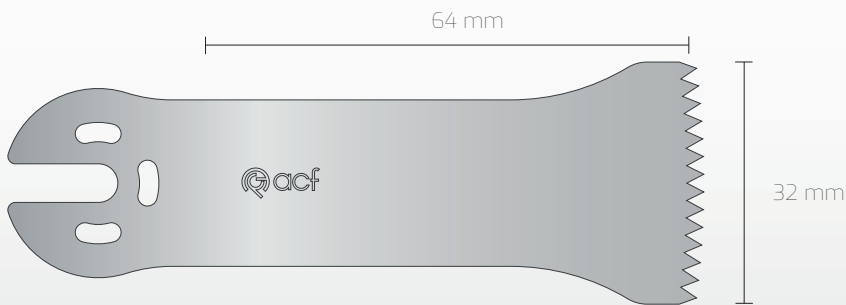

NON-STERILE REF	STERILE REF	Cutting Edge	Cutting Depth	Material Thickness	Cutting Thickness	Teeth
360 320 064 090	5 360 320 064 090	32 mm	64 mm	0,90 mm	0,90 mm	Straight

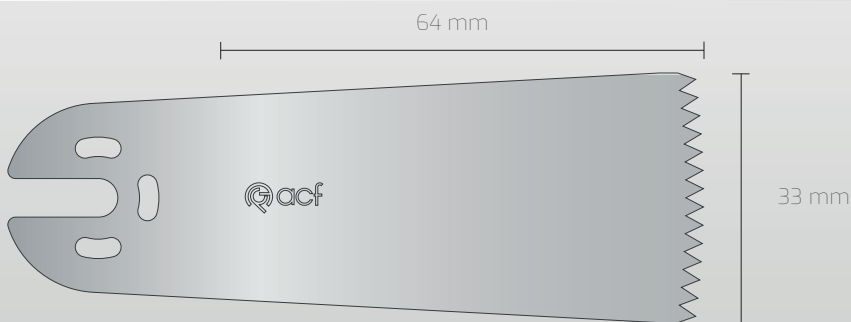

NON-STERILE REF	STERILE REF	Cutting Edge	Cutting Depth	Material Thickness	Cutting Thickness	Teeth
360 330 064 090	5 360 330 064 090	33 mm	64 mm	0,90 mm	0,90 mm	Straight

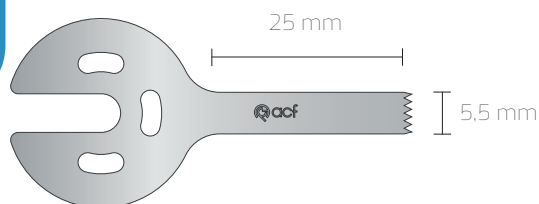

NON-STERILE REF	STERILE REF	Cutting Edge	Cutting Depth	Material Thickness	Cutting Thickness	Teeth
360 055 025 060	S 360 055 025 060	5,5 mm	25 mm	0,60 mm	0,60 mm	Straight

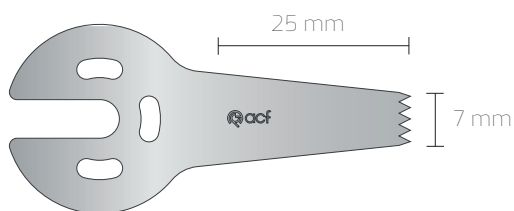

NON-STERILE REF	STERILE REF	Cutting Edge	Cutting Depth	Material Thickness	Cutting Thickness	Teeth
360 070 025 060	S 360 070 025 060	7 mm	25 mm	0,60 mm	0,60 mm	Straight
X 360 070 025 060	SX 360 070 025 060	7 mm	25 mm	0,60 mm	0,80 mm	Cross



NON-STERILE REF	STERILE REF	Cutting Edge	Cutting Depth	Material Thickness	Cutting Thickness	Teeth
360 090 025 060	S 360 090 025 060	9 mm	25 mm	0,60	0,60 mm	Straight
X 360 090 025 060	SX 360 090 025 060	9 mm	25 mm	0,60	0,80 mm	Cross

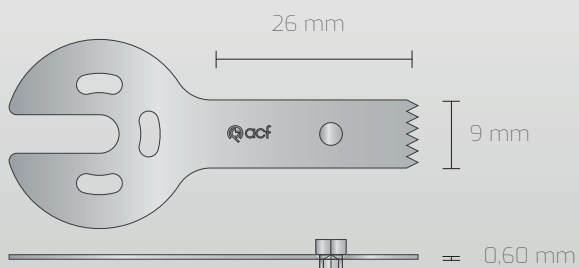

NON-STERILE REF	STERILE REF	Cutting Edge	Cutting Depth	Material Thickness	Cutting Thickness	Teeth
360 090 026 060	S 360 090 026 060	9 mm	26 mm	0,60 mm	0,60 mm	Straight



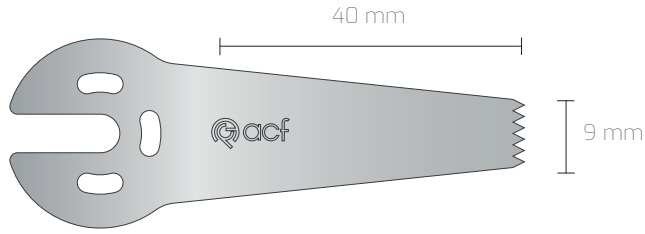

NON-STERILE REF	STERILE REF	Cutting Edge	Cutting Depth	Material Thickness	Cutting Thickness	Teeth
360 090 040 060	S 360 090 040 060	9 mm	40 mm	0,60 mm	0,60 mm	Straight
X 360 090 040 060	SX 360 090 040 060	9 mm	40 mm	0,60 mm	0,80 mm	Cross

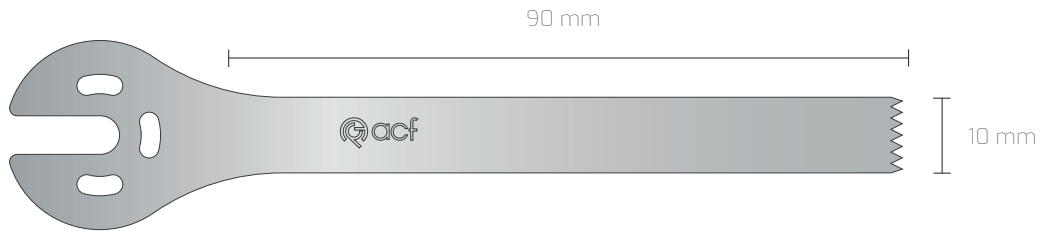

NON-STERILE REF	STERILE REF	Cutting Edge	Cutting Depth	Material Thickness	Cutting Thickness	Teeth
360 100 090 060	S 360 100 090 060	10 mm	90 mm	0,60 mm	0,60 mm	Straight
360 100 090 120	S 360 100 090 120	10 mm	90 mm	1,20 mm	1,20 mm	Straight

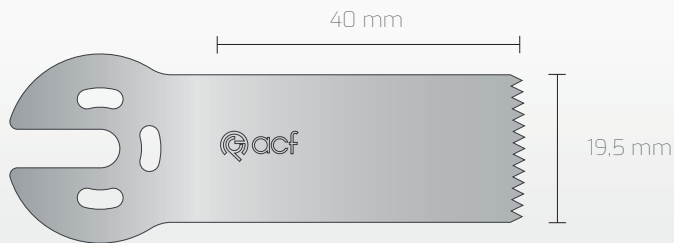

NON-STERILE REF	STERILE REF	Cutting Edge	Cutting Depth	Material Thickness	Cutting Thickness	Teeth
360 195 040 060	S 360 195 040 060	19,5 mm	40 mm	0,60 mm	0,60 mm	Straight
X 360 195 040 060	SX 360 195 040 060	19,5 mm	40 mm	0,60 mm	0,80 mm	Cross

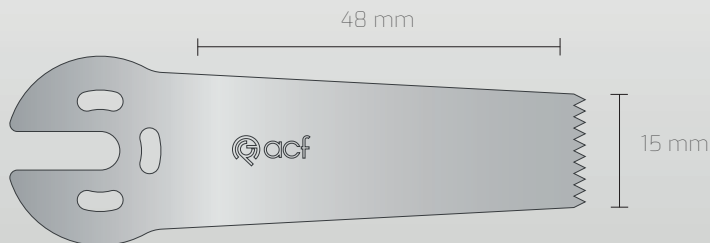

NON-STERILE REF	STERILE REF	Cutting Edge	Cutting Depth	Material Thickness	Cutting Thickness	Teeth
360 150 048 060	S 360 150 048 060	15 mm	48 mm	0,60 mm	0,60 mm	Straight
X 360 150 048 060	SX 360 150 048 060	15 mm	48 mm	0,60 mm	0,80 mm	Cross

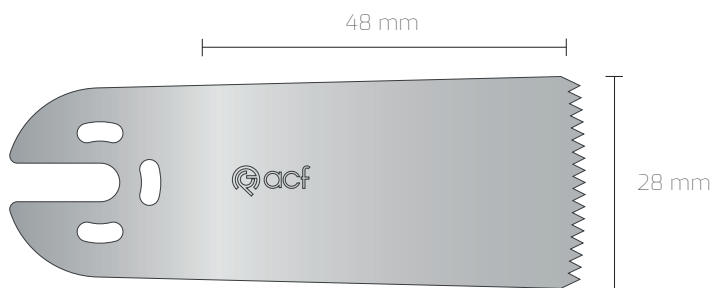

NON-STERILE REF	STERILE REF	Cutting Edge	Cutting Depth	Material Thickness	Cutting Thickness	Teeth
360 280 048 060	S 360 280 048 060	28 mm	48 mm	0,60 mm	0,60 mm	Straight
X 360 280 048 060	SX 360 280 048 060	28 mm	48 mm	0,60 mm	0,80 mm	Cross

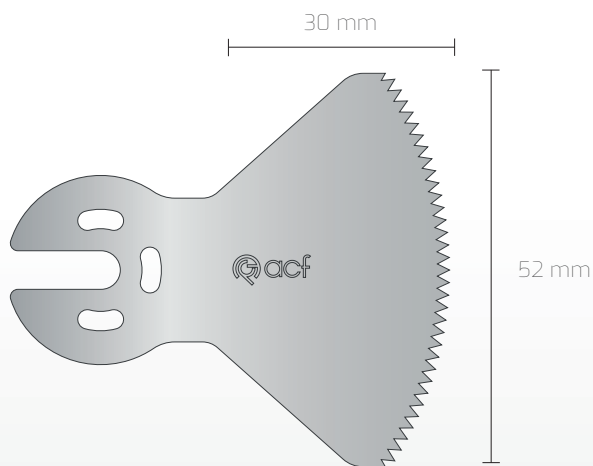

NON-STERILE REF	STERILE REF	Cutting Edge	Cutting Depth	Material Thickness	Cutting Thickness	Teeth
360 520 030 060	S 360 520 030 060	52 mm	30 mm	0,60 mm	0,60 mm	Straight
360 520 030 090	S 360 520 030 090	52 mm	30 mm	0,90 mm	0,90 mm	Straight
X 360 520 030 060	SX 360 520 030 060	52 mm	30 mm	0,60 mm	0,80 mm	Cross

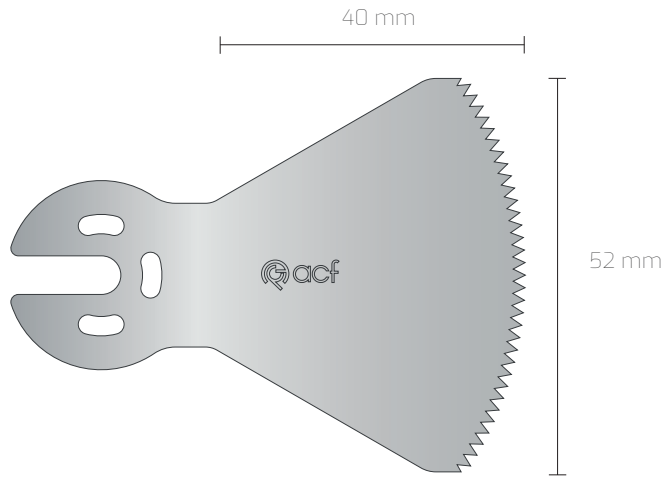

NON-STERILE REF	STERILE REF	Cutting Edge	Cutting Depth	Material Thickness	Cutting Thickness	Teeth
360 520 040 060	S 360 520 040 060	52 mm	40 mm	0,60 mm	0,60 mm	Straight
360 520 040 090	S 360 520 040 090	52 mm	40 mm	0,90 mm	0,90 mm	Straight
X 360 520 040 060	SX 360 520 040 060	52 mm	40 mm	0,60 mm	0,80 mm	Cross

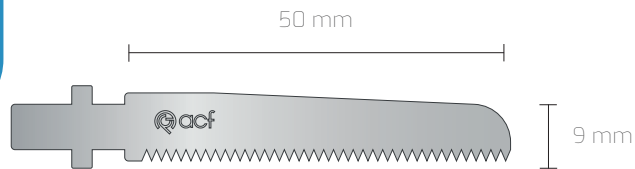

NON-STERILE REF	STERILE REF	Cutting Edge	Cutting Depth	Material Thickness	Cutting Thickness	Teeth
360 090 050 060	S 360 090 050 060	9 mm	50 mm	0,60 mm	0,60 mm	Straight
360 090 050 100	S 360 090 050 100	9 mm	50 mm	1,00 mm	1,00 mm	Straight
X 360 090 050 060	SX 360 090 050 060	9 mm	50 mm	0,60 mm	0,80 mm	Cross

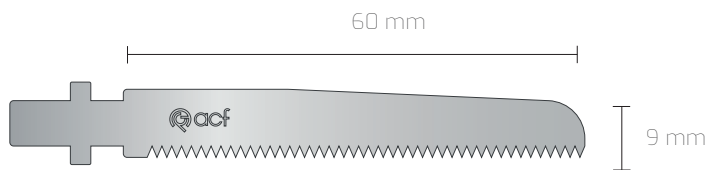

NON-STERILE REF	STERILE REF	Cutting Edge	Cutting Depth	Material Thickness	Cutting Thickness	Teeth
360 090 060 060	S 360 090 060 060	9 mm	60 mm	0,60 mm	0,60 mm	Straight
360 090 060 100	S 360 090 060 100	9 mm	60 mm	1,00 mm	1,00 mm	Straight
X 360 090 060 060	SX 360 090 060 060	9 mm	60 mm	0,60 mm	0,80 mm	Cross

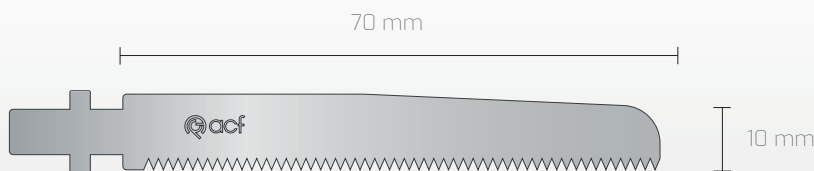

NON-STERILE REF	STERILE REF	Cutting Edge	Cutting Depth	Material Thickness	Cutting Thickness	Teeth
360 100 070 060	S 360 100 070 060	10 mm	70 mm	0,60 mm	0,60 mm	Straight
360 100 070 100	S 360 100 070 100	10 mm	70 mm	1,00 mm	1,00 mm	Straight

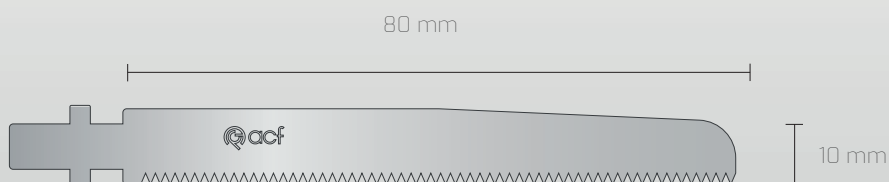

NON-STERILE REF	STERILE REF	Cutting Edge	Cutting Depth	Material Thickness	Cutting Thickness	Teeth
360 100 080 060	S 360 100 080 060	10 mm	80 mm	0,60 mm	0,60 mm	Straight
360 100 080 100	S 360 100 080 100	10 mm	80 mm	1,00 mm	1,00 mm	Straight

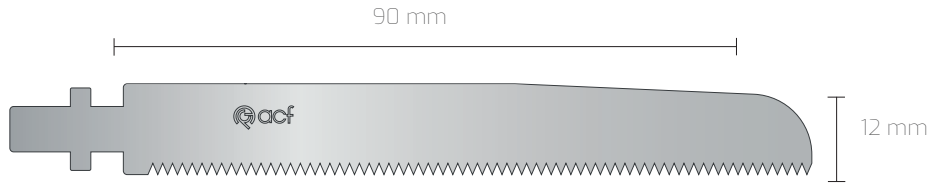

NON-STERILE REF	STERILE REF	Cutting Edge	Cutting Depth	Material Thickness	Cutting Thickness	Teeth
360 120 090 060	S 360 120 090 060	12 mm	90 mm	0,60 mm	0,60 mm	Straight
360 120 090 100	S 360 120 090 100	12 mm	90 mm	1,00 mm	1,00 mm	Straight

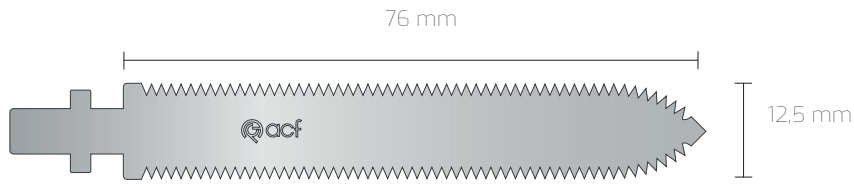

NON-STERILE REF	STERILE REF	Cutting Edge	Cutting Depth	Material Thickness	Cutting Thickness	Teeth
360 125 076 060	S 360 125 076 060	12,5 mm	76 mm	0,60 mm	0,60 mm	Straight
360 125 076 100	S 360 125 076 100	12,5 mm	76 mm	1,00 mm	1,00 mm	Straight



---

ACF Medikal Urunler Mak. San. ve Tic. Ltd. Sti.

Guzelyurt Mah. 5754 Sok. No: 3/A  
Yunusemre / Manisa, Turkey, 45030

+90 236 236 28 20

info@acf.com.tr

[www.acf.com.tr](http://www.acf.com.tr)