

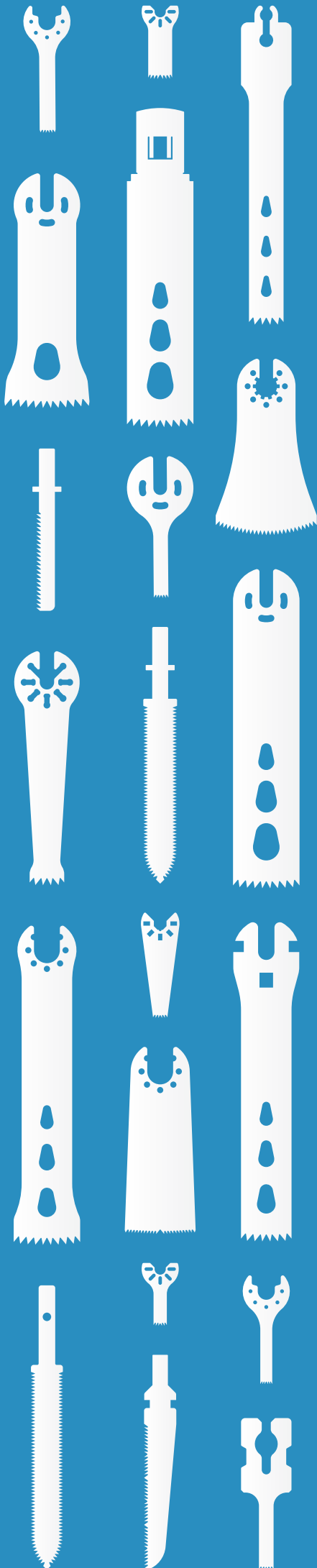

Durable.
Stylish.
That's All You Need.

Surgical Saw Blades

Product Catalog





Saw Blades
Compatible with
STRYKER[®]



Brand Code **120**

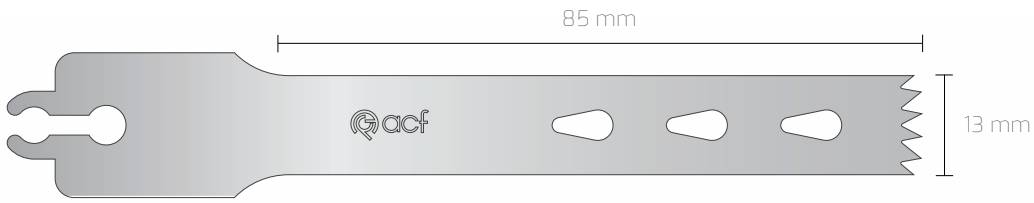

● Non Sterile
 ● Sterile R

Ref	120 130 085 089	120 130 085 090	120 130 085 100	120 130 085 119	120 130 085 120
Thickness	0,89 mm	0,90 mm	1,00 mm	1,19 mm	1,20 mm

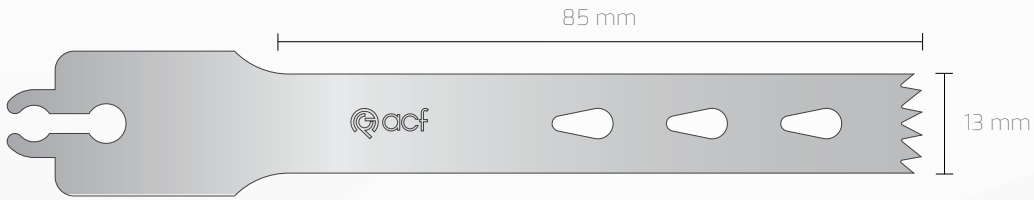

● Non Sterile
 ● Sterile R

Ref	120 130 085 127	120 130 085 130	120 130 085 137	120 130 085 140	120 130 085 147
Thickness	1,27 mm	1,30 mm	1,37 mm	1,40 mm	1,47 mm

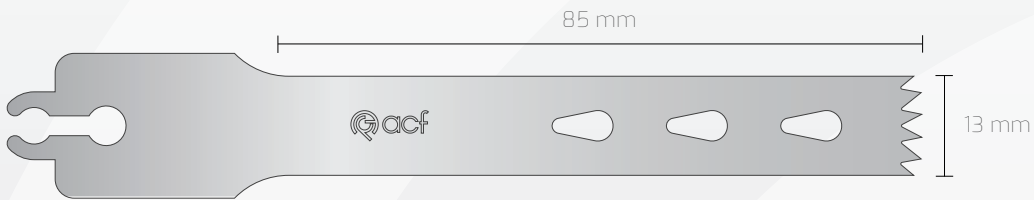

● Non Sterile
 ● Sterile R

Ref	120 130 085 150
Thickness	1,50 mm

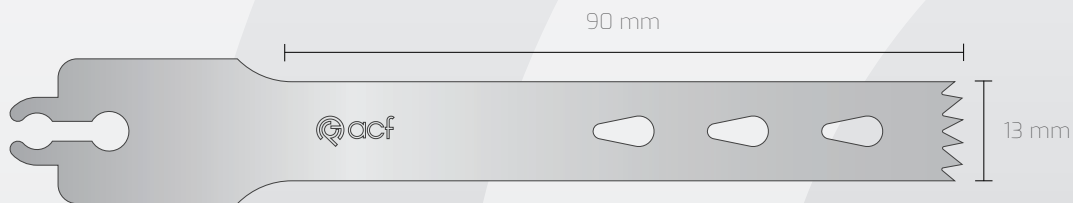

● Non Sterile
 ● Sterile R

Ref	120 130 090 089	120 130 090 090	120 130 090 100	120 130 090 119	120 130 090 120
Thickness	0,89 mm	0,90 mm	1,00 mm	1,19 mm	1,20 mm

Stryker®

Compatible Connections:
Stryker System EHD(296-98),
2000(2108), 54(4108), 55(4208),
56(6208), 57(7208), 58(8208)

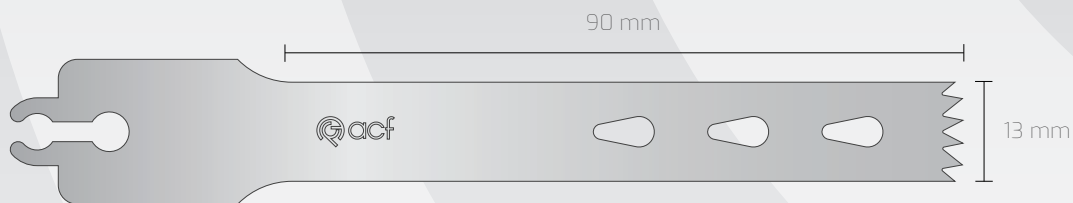

● Non Sterile
● Sterile R

Ref	120 130 090 127	120 130 090 130	120 130 090 137	120 130 090 140	120 130 090 147
Thickness	1,27 mm	1,30 mm	1,37 mm	1,40 mm	1,47 mm

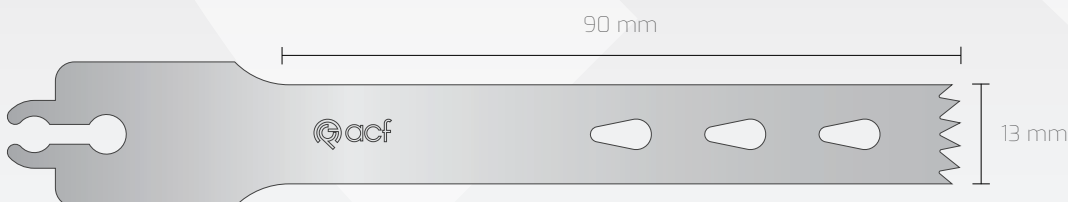

● Non Sterile
● Sterile R

Ref	120 130 090 150
Thickness	1,50 mm

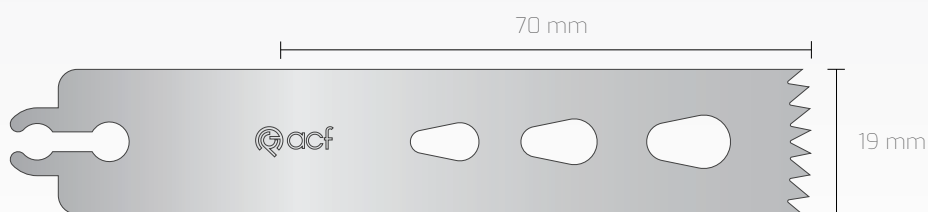

● Non Sterile
● Sterile R

Ref	120 190 070 120
Thickness	1,20 mm



● Non Sterile
● Sterile R

Ref	120 190 085 089	120 190 085 090	120 190 085 100	120 190 085 119	120 190 085 120
Thickness	0,89 mm	0,90 mm	1,00 mm	1,19 mm	1,20 mm

All saw blades are shown in actual size. 1:1

STRYKER®

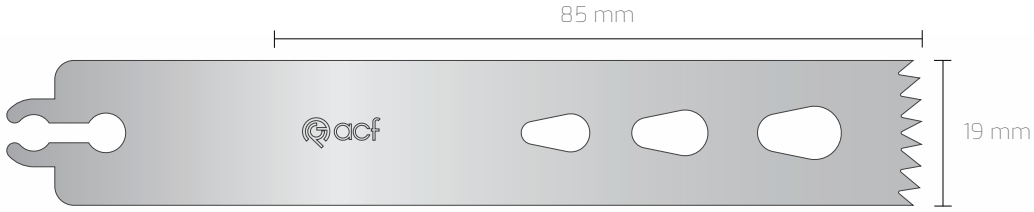

● Non Sterile
● Sterile R

Ref	120 190 085 127	120 190 085 130	120 190 085 137	120 190 085 140	120 190 085 147
Thickness	1,27 mm	1,30 mm	1,37 mm	1,40 mm	1,47 mm

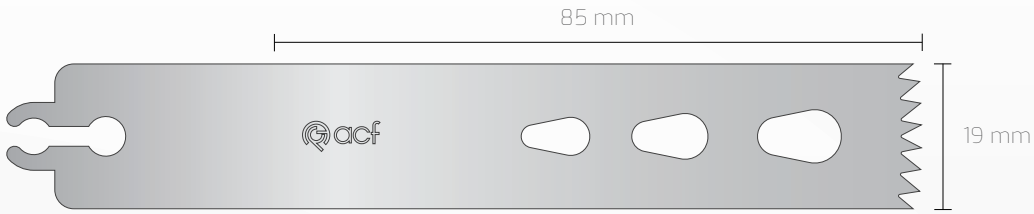

● Non Sterile
● Sterile R

Ref	120 190 085 150
Thickness	1,50 mm

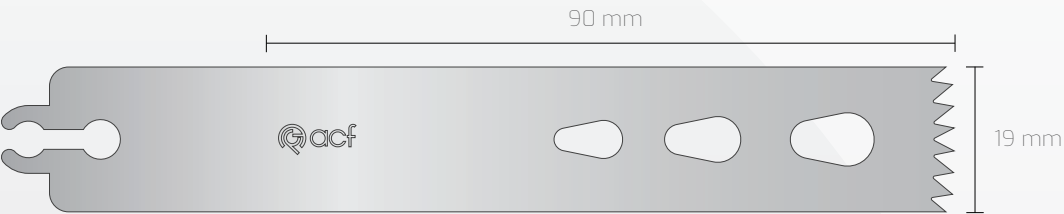

● Non Sterile
● Sterile R

Ref	120 190 090 089	120 190 090 090	120 190 090 100	120 190 090 119	120 190 090 120
Thickness	0,89 mm	0,90 mm	1,00 mm	1,19 mm	1,20 mm

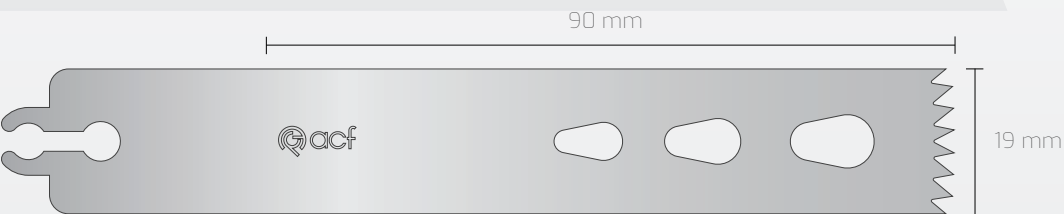

● Non Sterile
● Sterile R

Ref	120 190 090 127	120 190 090 130	120 190 090 137	120 190 090 140	120 190 090 147
Thickness	1,27 mm	1,30 mm	1,37 mm	1,40 mm	1,47 mm

Stryker®

Compatible Connections:
 Stryker System EHD(296-98),
 2000(2108), 54(4108), 55(4208),
 56(6208), 57(7208), 58(8208)

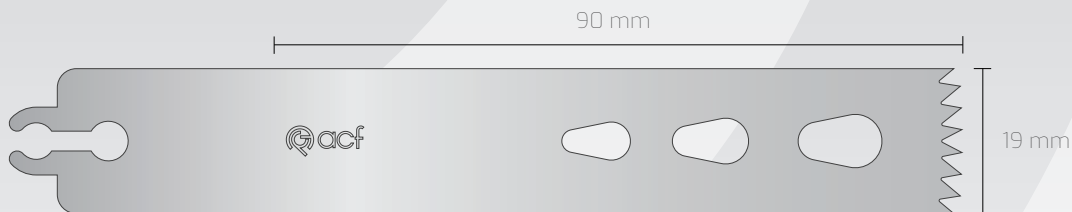

- Non Sterile
- Sterile R

Ref 120 190 090 150

Thickness 1,50 mm

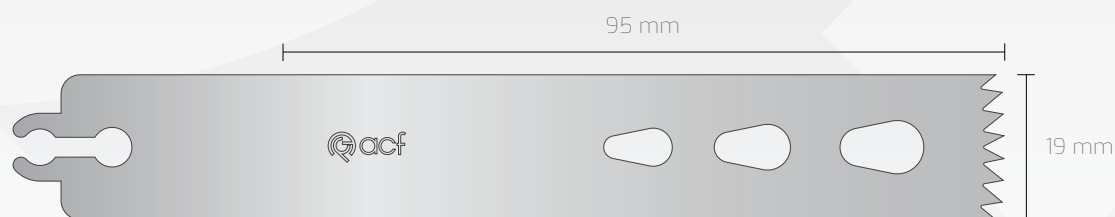

- Non Sterile
- Sterile R

Ref 120 190 095 100

Thickness 1,00 mm

Ref 120 190 095 120

Thickness 1,20 mm

Ref 120 190 095 127

Thickness 1,27 mm



- Non Sterile
- Sterile R

Ref 120 190 100 089

Thickness 0,89 mm

Ref 120 190 100 090

Thickness 0,90 mm

Ref 120 190 100 100

Thickness 1,00 mm

Ref 120 190 100 119

Thickness 1,19 mm

Ref 120 190 100 120

Thickness 1,20 mm

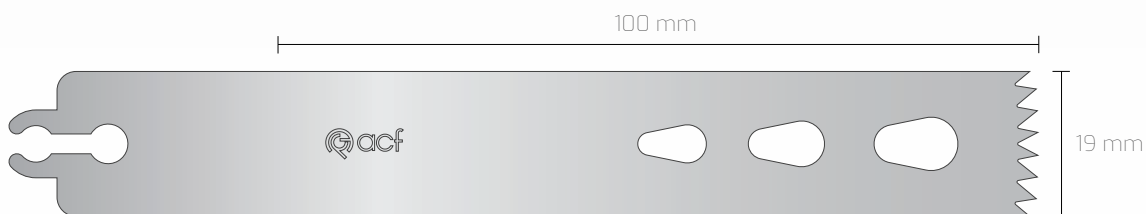

- Non Sterile
- Sterile R

Ref 120 190 100 127

Thickness 1,27 mm

Ref 120 190 100 130

Thickness 1,30 mm

Ref 120 190 100 137

Thickness 1,37 mm

Ref 120 190 100 140

Thickness 1,40 mm

Ref 120 190 100 147

Thickness 1,47 mm

All saw blades are shown in actual size. 1:1

STRYKER®

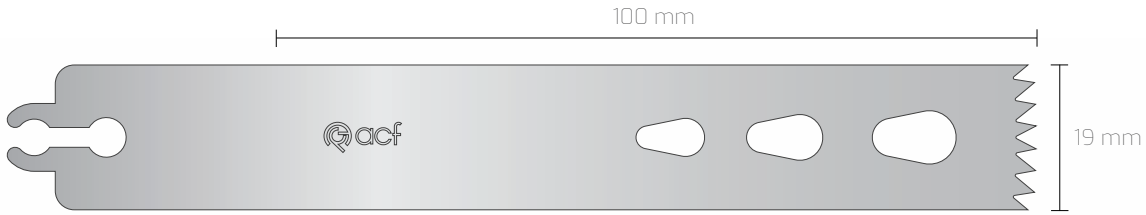

● Non Sterile
● Sterile R

Ref 120 190 100 150
Thickness 1,50 mm

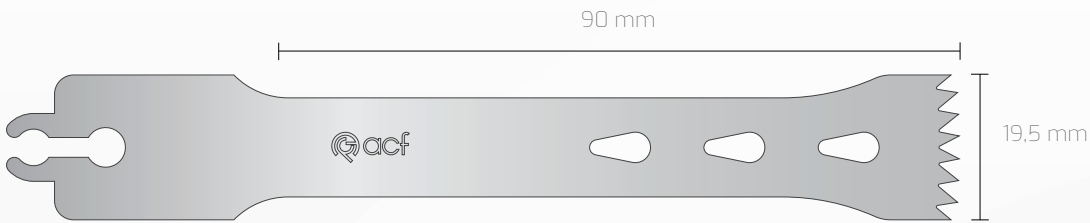

● Non Sterile
● Sterile R

Ref	120 195 090 089	120 195 090 090	120 195 090 100	120 195 090 119	120 195 090 120
Thickness	0,89 mm	0,90 mm	1,00 mm	1,19 mm	1,20 mm

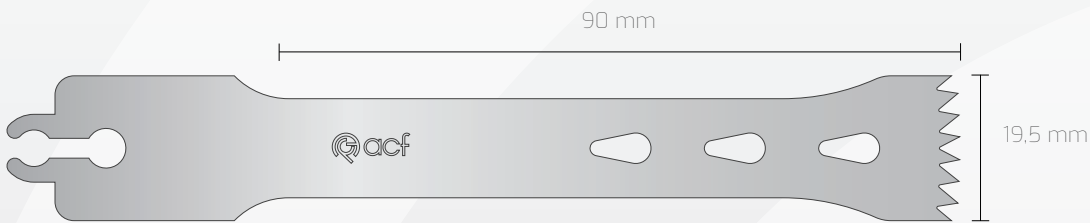

● Non Sterile
● Sterile R

Ref	120 195 090 127	120 195 090 130	120 195 090 137	120 195 090 140	120 195 090 147
Thickness	1,27 mm	1,30 mm	1,37 mm	1,40 mm	1,47 mm

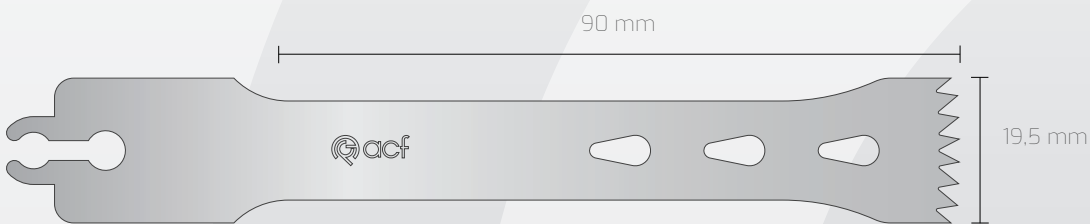

● Non Sterile
● Sterile R

Ref 120 195 090 150
Thickness 1,50 mm

Stryker®

Compatible Connections;
Stryker System EHD(296-98),
2000(2108), 54(4108), 55(4208),
56(6208), 57(7208), 58(8208)

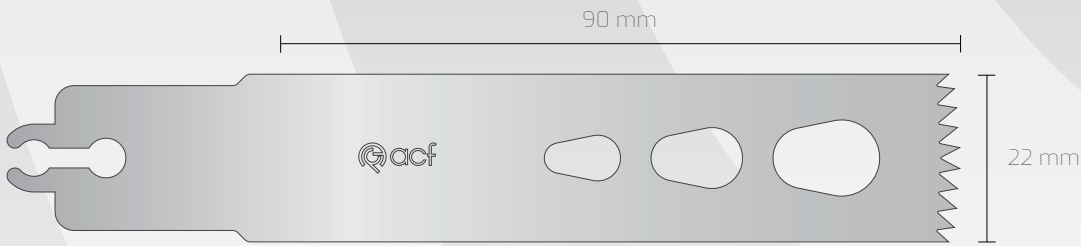

● Non Sterile
● Sterile R

Ref	120 220 090 089	120 220 090 090	120 220 090 100	120 220 090 119	120 220 090 120
Thickness	0,89 mm	0,90 mm	1,00 mm	1,19 mm	1,20 mm



● Non Sterile
● Sterile R

Ref	120 220 090 127	120 220 090 130	120 220 090 137	120 220 090 140	120 220 090 147
Thickness	1,27 mm	1,30 mm	1,37 mm	1,40 mm	1,47 mm

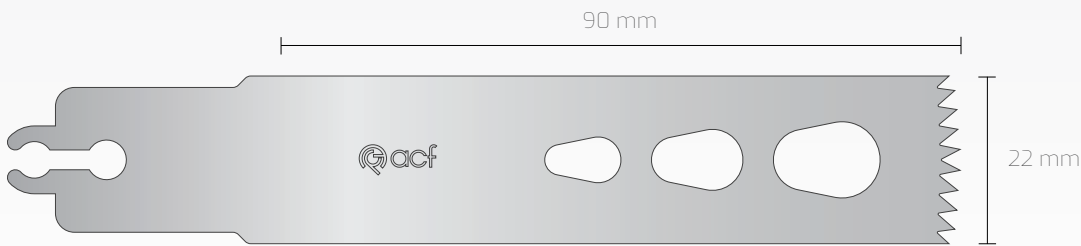

● Non Sterile
● Sterile R

Ref	120 220 090 150
Thickness	1,50 mm

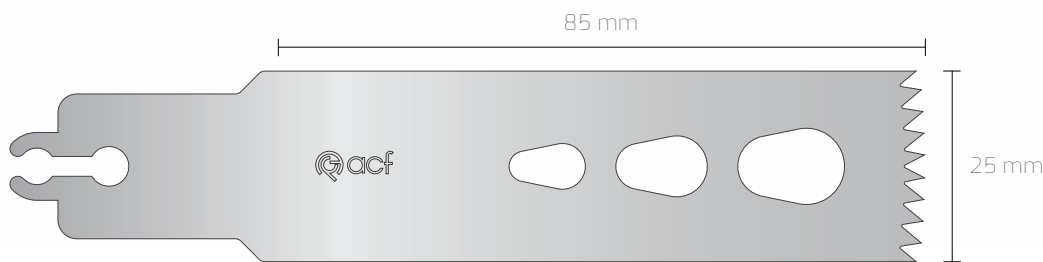

● Non Sterile
● Sterile R

Ref	120 250 085 089	120 250 085 090	120 250 085 100	120 250 085 119	120 250 085 120
Thickness	0,89 mm	0,90 mm	1,00 mm	1,19 mm	1,20 mm

All saw blades are shown in actual size. 1:1

STRYKER®

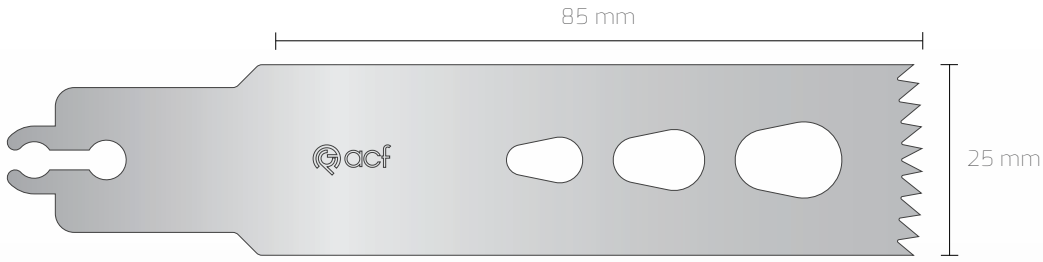

● Non Sterile
 ● Sterile R

Ref	120 250 085 127	120 250 085 130	120 250 085 137	120 250 085 140	120 250 085 147
Thickness	1,27 mm	1,30 mm	1,37 mm	1,40 mm	1,47 mm

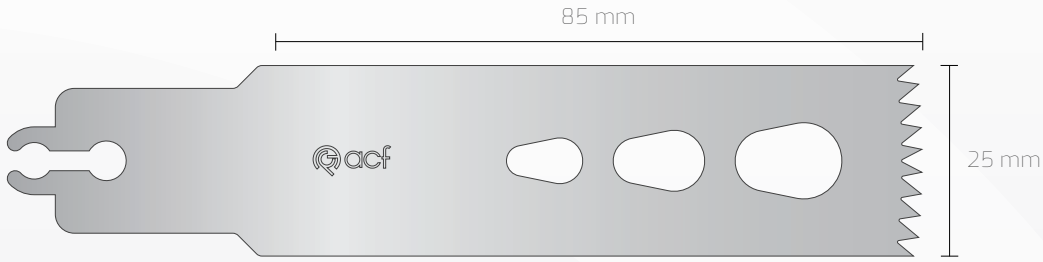

● Non Sterile
 ● Sterile R

Ref	120 250 085 150
Thickness	1,50 mm

Stryker®

Compatible Connections:

Stryker System EHD(296-98),
2000(2108), 54(4108), 55(4208),
56(6208), 57(7208), 58(8208)

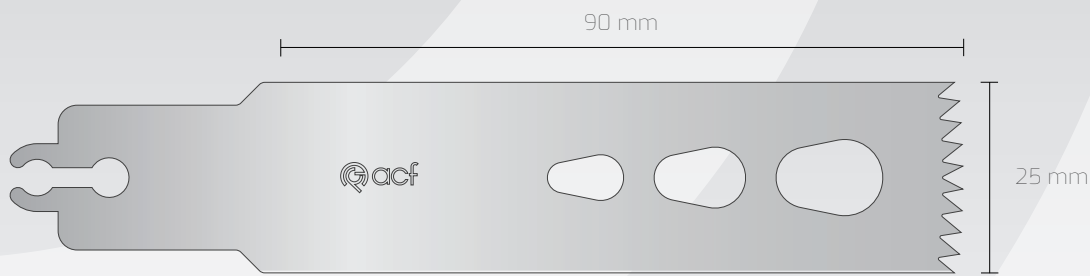

- Non Sterile
- Sterile R

Ref	120 250 090 089	120 250 090 090	120 250 090 100	120 250 090 119	120 250 090 120
Thickness	0,89 mm	0,90 mm	1,00 mm	1,19 mm	1,20 mm

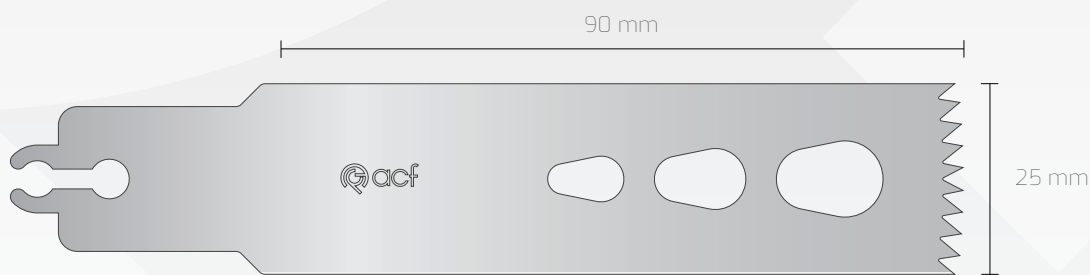

- Non Sterile
- Sterile R

Ref	120 250 090 127	120 250 090 130	120 250 090 137	120 250 090 140	120 250 090 147
Thickness	1,27 mm	1,30 mm	1,37 mm	1,40 mm	1,47 mm

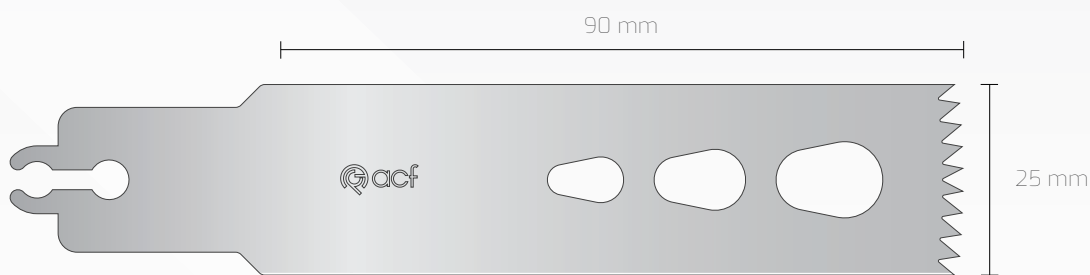

- Non Sterile
- Sterile R

Ref	120 250 090 150
Thickness	1,50 mm



- Non Sterile
- Sterile R

Ref	120 250 095 100	120 250 095 120	120 250 095 127
Thickness	1,00 mm	1,20 mm	1,27 mm

All saw blades are shown in actual size. 1:1

STRYKER®

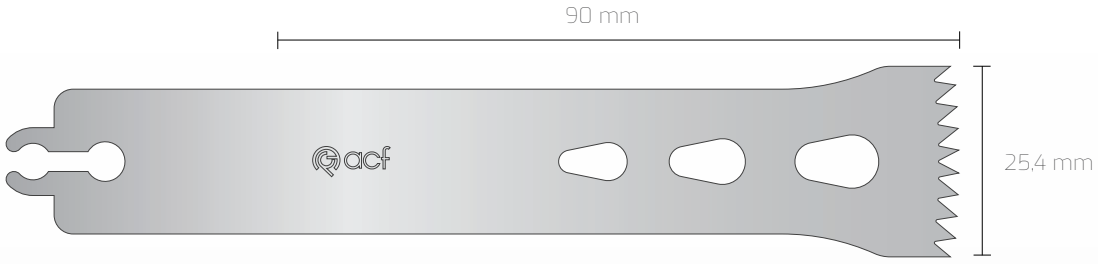

● Non Sterile
● Sterile R

Ref	120 254 090 089	120 254 090 090	120 254 090 100	120 254 090 119	120 254 090 120
Thickness	0,89 mm	0,90 mm	1,00 mm	1,19 mm	1,20 mm

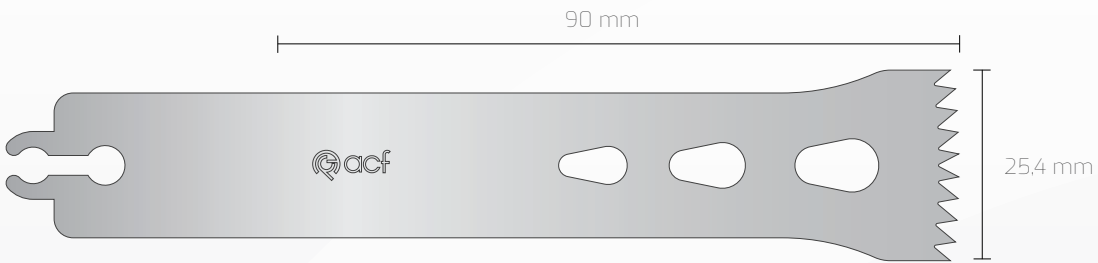

● Non Sterile
● Sterile R

Ref	120 254 090 127	120 254 090 130	120 254 090 137	120 254 090 140	120 254 090 147
Thickness	1,27 mm	1,30 mm	1,37 mm	1,40 mm	1,47 mm

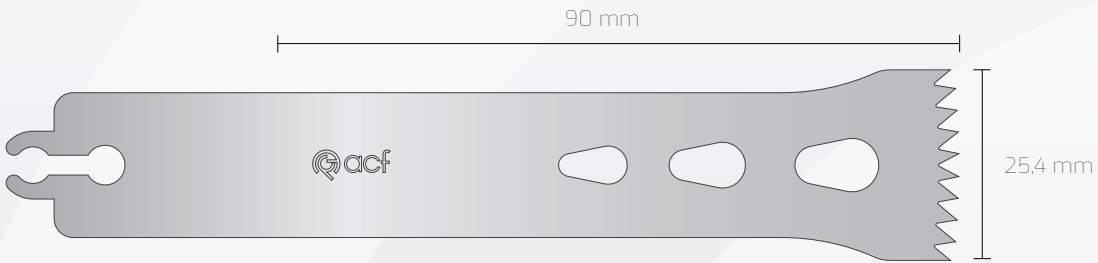

● Non Sterile
● Sterile R

Ref	120 254 090 150
Thickness	1,50 mm

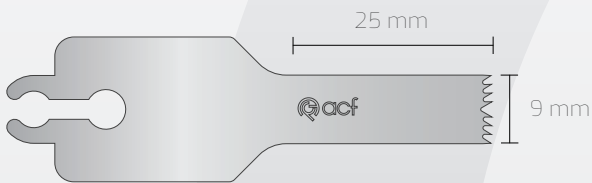

● Non Sterile
● Sterile R

Ref	120 090 025 060
Thickness	0,60 mm

Stryker®

Compatible Connections:
Stryker System EHD(296-98),
2000(2108), 54(4108), 55(4208),
56(6208), 57(7208), 58(8208)

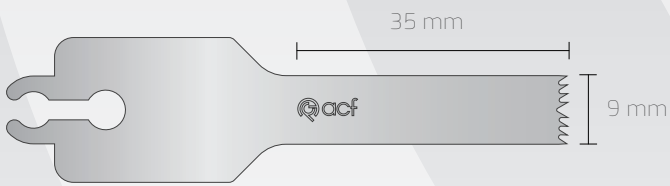

● Non Sterile
● Sterile R

Ref 120 090 035 060

Thickness 0,60 mm

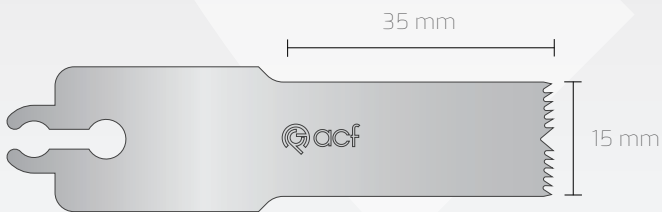

● Non Sterile
● Sterile R

Ref 120 150 035 060

Thickness 0,60 mm



● Non Sterile
● Sterile R

Ref 120 270 058 060

Thickness 0,60 mm

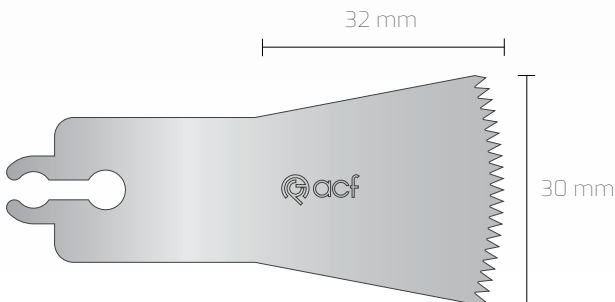

● Non Sterile
● Sterile R

Ref 120 300 032 060

Thickness 0,60 mm

STRYKER®

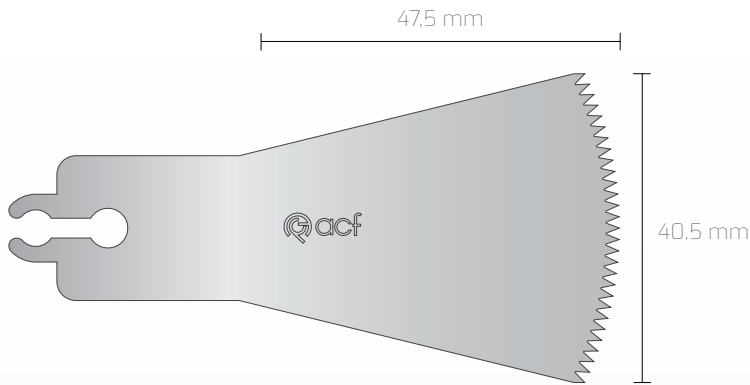

- Non Sterile
- Sterile R

Ref **120 405 475 060**
 Thickness 0,60 mm

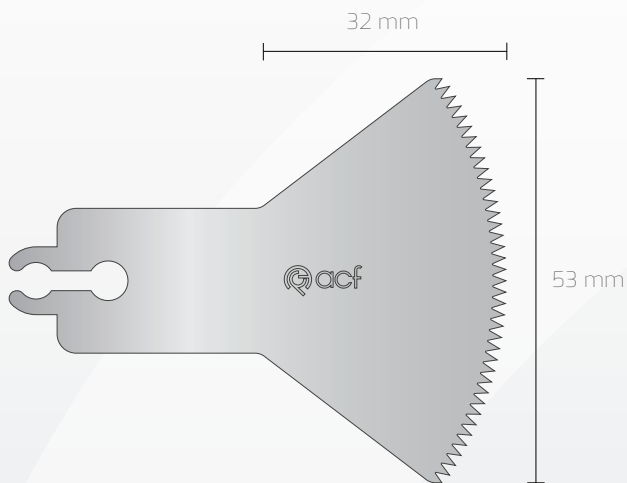

- Non Sterile
- Sterile R

Ref **120 530 032 060**
 Thickness 0,60 mm

Stryker®

Compatible Connections:
Stryker System EHD(296-98),
2000(2108), 54(4108), 55(4208),
56(6208), 57(7208), 58(8208)

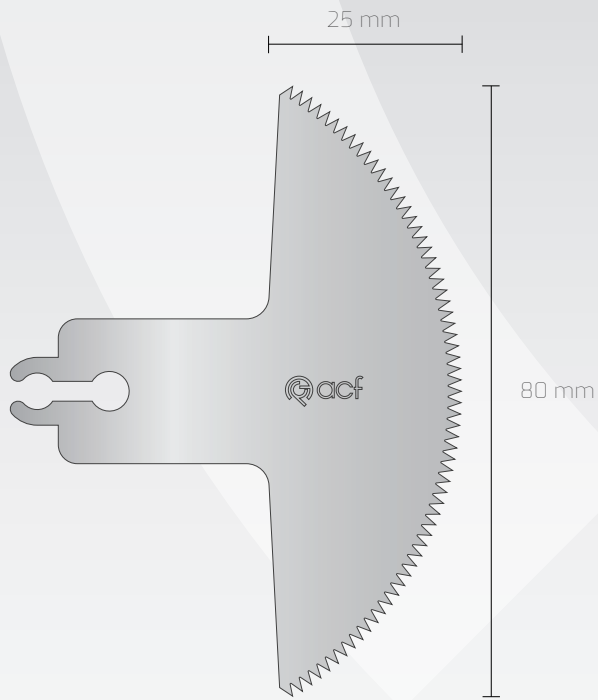

- Non Sterile
- Sterile R

Ref	120 800 025 060
Thickness	0,60 mm

STRYKER®



Ref	120 060 032 060
Thickness	0,60 mm

Stryker®

Compatible Connections:
4206, 4106, 2106, 296-96,
6206, 7206, 8206
Reciprocating Saws



● Non Sterile
● Sterile R

Ref 120 060 060 060

Thickness 0,60 mm

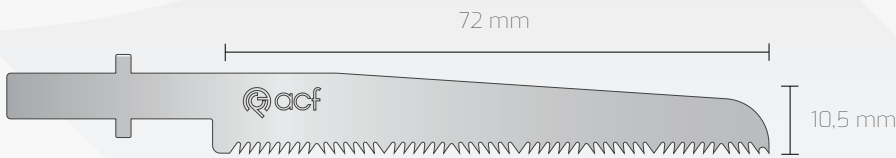

● Non Sterile
● Sterile R

Ref 120 105 072 060

Thickness 0,60 mm

Ref 120 105 072 090

Thickness 0,90 mm

Ref 120 105 072 100

Thickness 1,00 mm

Ref 120 105 072 120

Thickness 1,20 mm

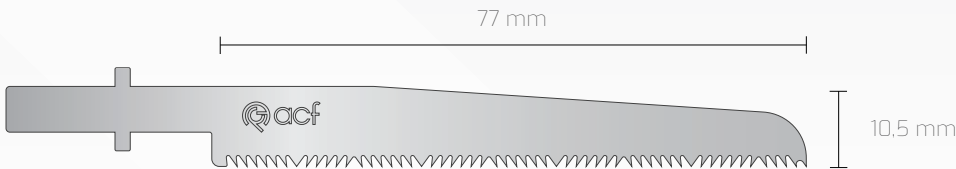

● Non Sterile
● Sterile R

Ref 120 105 077 060

Thickness 0,60 mm

Ref 120 105 077 090

Thickness 0,90 mm

Ref 120 105 077 100

Thickness 1,00 mm

Ref 120 105 077 120

Thickness 1,20 mm

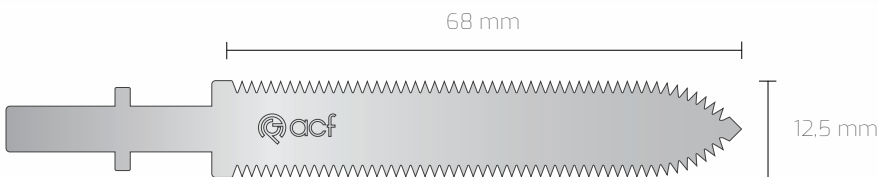

● Non Sterile
● Sterile R

Ref 120 125 068 090

Thickness 0,90 mm

Ref 120 125 068 100

Thickness 1,00 mm

Ref 120 125 068 120

Thickness 1,20 mm

All saw blades are shown in actual size. 1:1

STRYKER®

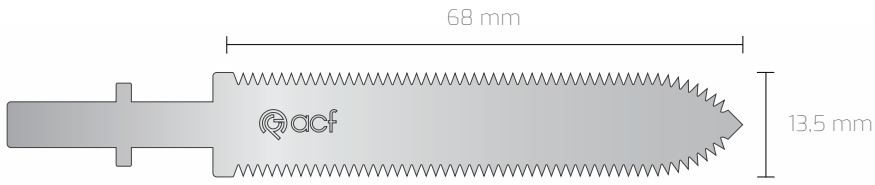

- Non Sterile
- Sterile R

Ref	120 135 068 090	120 135 068 100	120 135 068 120
Thickness	0,90 mm	1,00 mm	1,20 mm

Compatible Connections:

TPS5100-34 Sagittal Saw, TPS5100-31 Oscillating Saw, Command2 2296-31, 2296-234, 2296-34, 2296-231, 2296-080-134, Cordless Driver 2+3+4 Att. 4100-400, Sabo Sagittal Saw 4300-034, Sabo 2 4408-000, Micro Bone Saw, Core 5400-34, 5400-31, NSK Primado, RemB Micro Power 6400-034, 6400-031, 4100-400



● Non Sterile
● Sterile R

Ref 120 025 018 060

Thickness 0,60 mm

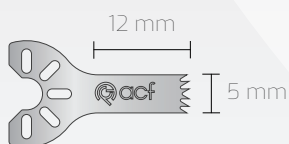

● Non Sterile
● Sterile R

Ref 120 050 012 060

Thickness 0,60 mm

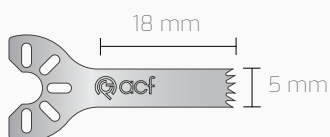

● Non Sterile
● Sterile R

Ref 120 050 018 060

Thickness 0,60 mm

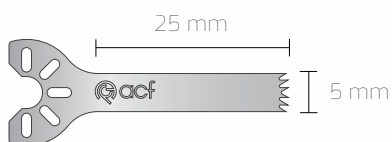

● Non Sterile
● Sterile R

Ref 120 050 025 060

Thickness 0,60 mm

Compatible Connections:
 TP55100-34 Sagittal Saw, TP55100-31 Oscillating Saw, Command2 2296-31, 2296-234, 2296-34, 2296-231, 2296-080-134, Cordless Driver 2+3+4 Att. 4100-400, Sabo Sagittal Saw 4300-034, Sabo 2 4408-000, Micro Bone Saw, Core 5400-34, 5400-31, NSK Primado, RemB Micro Power 6400-034, 6400-031, 4100-400

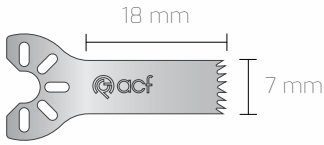

● Non Sterile
 ● Sterile R

Ref 120 070 018 060
 Thickness 0,60 mm

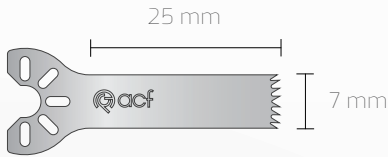

● Non Sterile
 ● Sterile R

Ref 120 070 025 060
 Thickness 0,60 mm

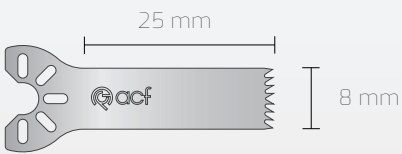

● Non Sterile
 ● Sterile R

Ref 120 080 025 060
 Thickness 0,60 mm

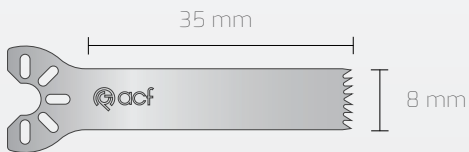

● Non Sterile
 ● Sterile R

Ref 120 080 035 060
 Thickness 0,60 mm

Stryker®

Compatible Connections;

TP55100-34 Sagittal Saw, TP55100-31 Oscillating Saw, Command2 2296-31, 2296-234, 2296-34, 2296-231, 2296-080-134, Cordless Driver 2+3+4 Att. 4100-400, Sabo Sagittal Saw 4300-034, Sabo 2 4408-000, Micro Bone Saw, Core 5400-34, 5400-31, NSK Primado, RemB Micro Power 6400-034, 6400-031, 4100-400

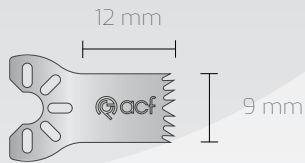

● Non Sterile
● Sterile R

Ref 120 090 012 060

Thickness 0,60 mm

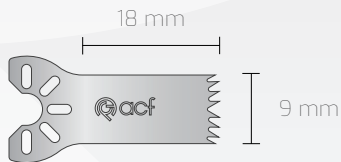

● Non Sterile
● Sterile R

Ref 120 090 018 060

Thickness 0,60 mm

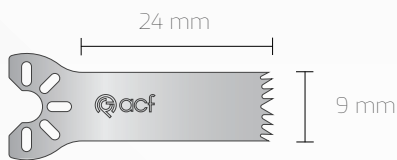

● Non Sterile
● Sterile R

Ref 120 090 024 060

Thickness 0,60 mm

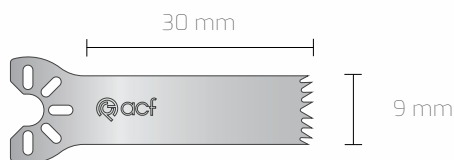

● Non Sterile
● Sterile R

Ref 120 090 030 060

Thickness 0,60 mm

STRYKER®

Compatible Connections:
 TPS5100-34 Sagittal Saw, TPS5100-31 Oscillating Saw, Command2 2296-31, 2296-234, 2296-34, 2296-231, 2296-080-134, Cordless Driver 2+3+4 Att. 4100-400, Sabo Sagittal Saw 4300-034, Sabo 2 4408-000, Micro Bone Saw, Core 5400-34, 5400-31, NSK Primado, RemB Micro Power 6400-034, 6400-031, 4100-400

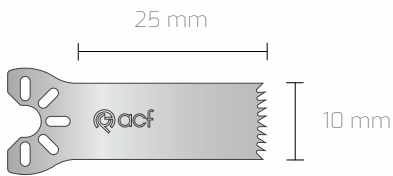

● Non Sterile
 ● Sterile R

Ref 120 100 025 060
 Thickness 0,60 mm

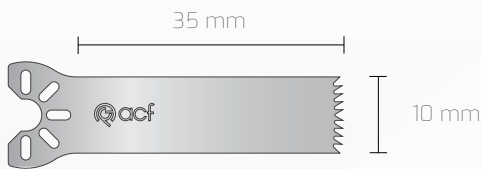

● Non Sterile
 ● Sterile R

Ref 120 100 035 060
 Thickness 0,60 mm

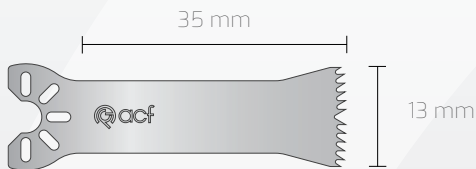

● Non Sterile
 ● Sterile R

Ref 120 130 035 060
 Thickness 0,60 mm

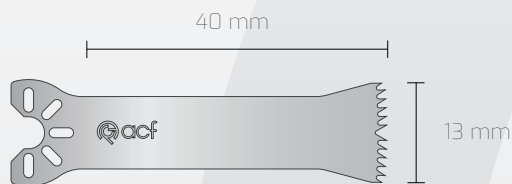

● Non Sterile
 ● Sterile R

Ref 120 130 040 060
 Thickness 0,60 mm



ACF Medikal Urunler Mak. San. ve Tic. Ltd. Sti.

Guzelyurt Mah. 5754 Sok. No: 3/A
Yunusemre / Manisa, Turkey, 45030

+90 236 236 28 20

info@acf.com.tr

www.acf.com.tr



ACF.MR.03.EN.R07 20.09.2021