

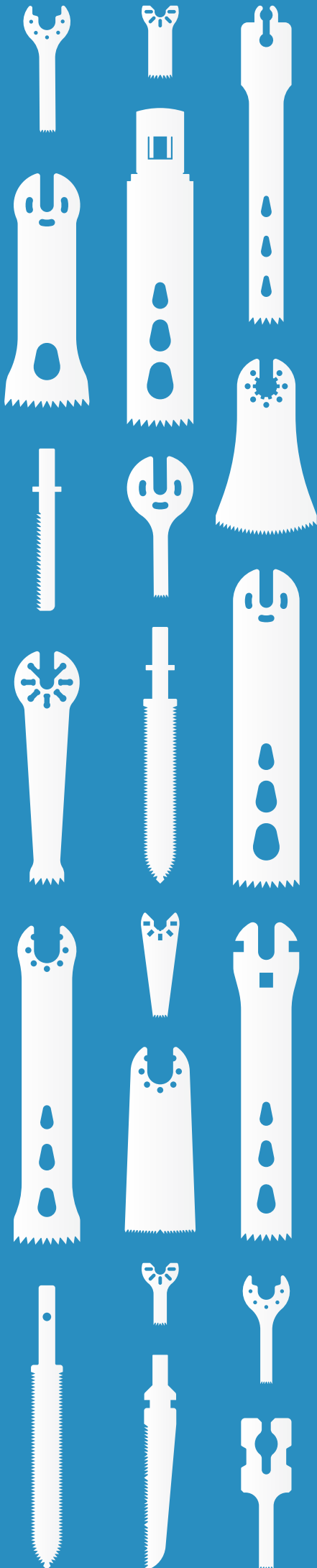

Durable.
Stylish.
That's All You Need.

Surgical Saw Blades

Product Catalog





Saw Blades
Compatible with
BRASSELER[®] / TAVA[®]



Brand Code **260**

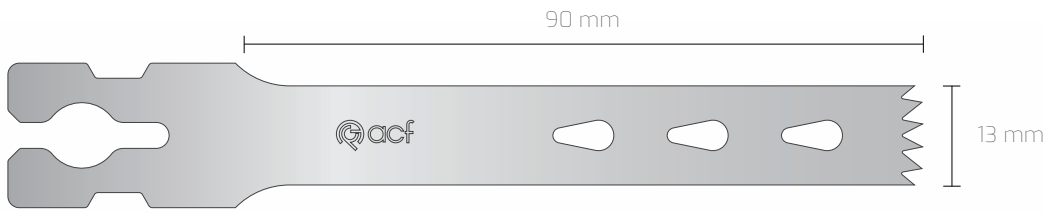

Ref	260 130 090 089	260 130 090 090	260 130 090 100	260 130 090 119	260 130 090 120
Thickness	0,89 mm	0,90 mm	1,00 mm	1,19 mm	1,20 mm

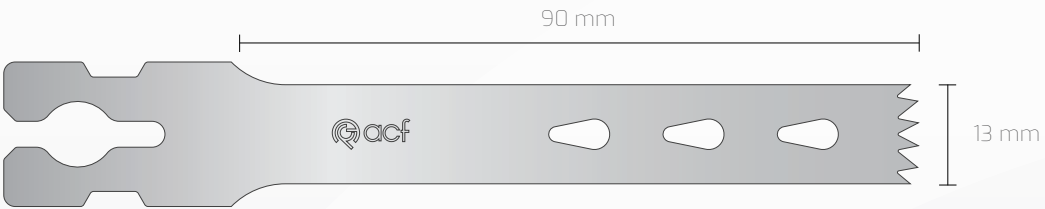

Ref	260 130 090 127	260 130 090 130	260 130 090 137	260 130 090 140	260 130 090 147
Thickness	1,27 mm	1,30 mm	1,37 mm	1,40 mm	1,47 mm

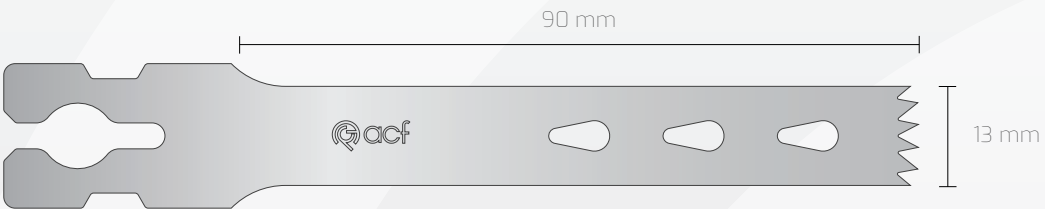

Ref	260 130 090 150
Thickness	1,50 mm

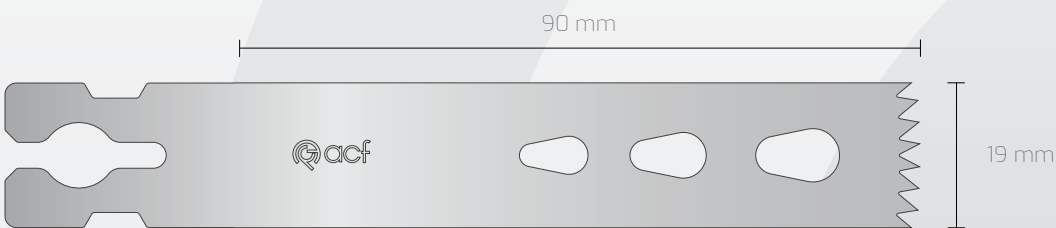

Ref	260 190 090 089	260 190 090 090	260 190 090 100	260 190 090 119	260 190 090 120
Thickness	0,89 mm	0,90 mm	1,00 mm	1,19 mm	1,20 mm

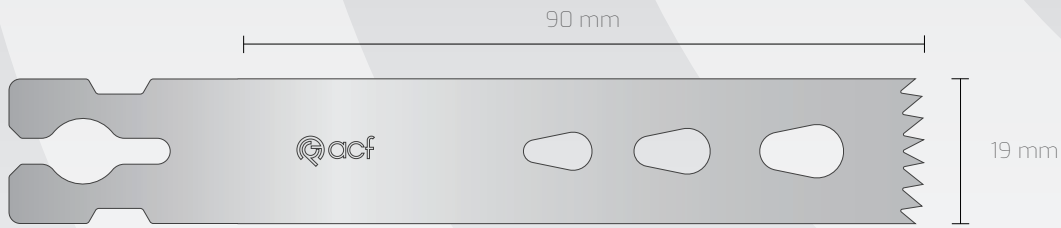

● Non Sterile
● Sterile R

Ref	260 190 090 127	260 190 090 130	260 190 090 137	260 190 090 140	260 190 090 147
Thickness	1,27 mm	1,30 mm	1,37 mm	1,40 mm	1,47 mm



● Non Sterile
● Sterile R

Ref	260 190 090 150
Thickness	1,50 mm

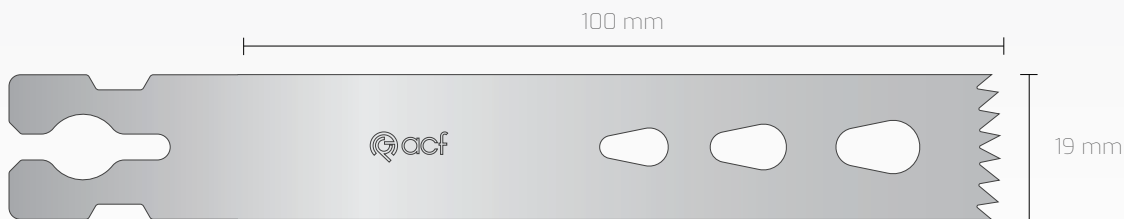

● Non Sterile
● Sterile R

Ref	260 190 100 089	260 190 100 090	260 190 100 100	260 190 100 119	260 190 100 120
Thickness	0,89 mm	0,90 mm	1,00 mm	1,19 mm	1,20 mm

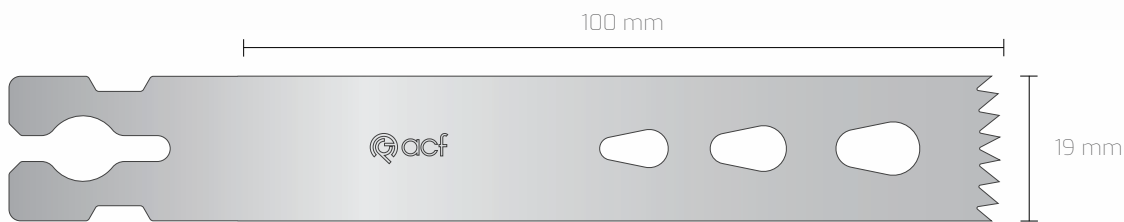

● Non Sterile
● Sterile R

Ref	260 190 100 127	260 190 100 130	260 190 100 137	260 190 100 140	260 190 100 147
Thickness	1,27 mm	1,30 mm	1,37 mm	1,40 mm	1,47 mm

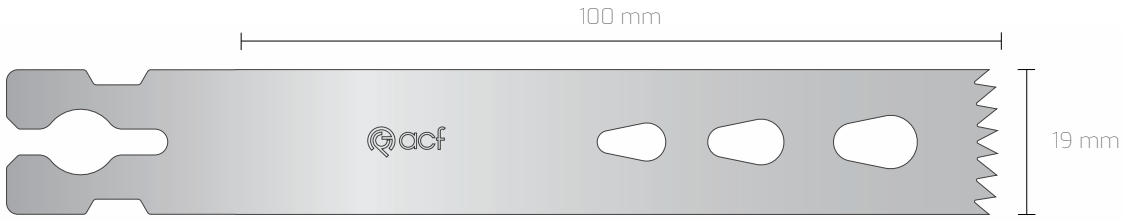

● Non Sterile
 ● Sterile R

Ref 260 190 100 150
 Thickness 1,50 mm

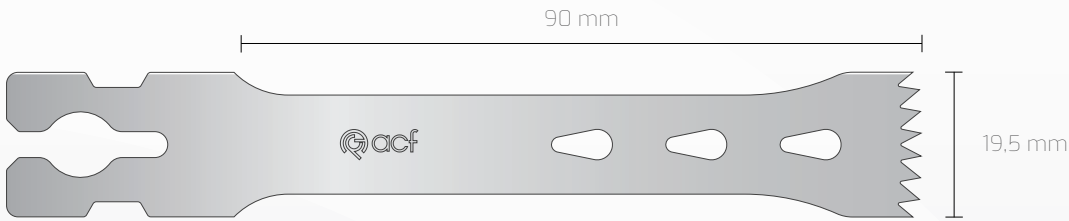

● Non Sterile
 ● Sterile R

Ref	260 195 090 089	260 195 090 090	260 195 090 100	260 195 090 119	260 195 090 120
Thickness	0,89 mm	0,90 mm	1,00 mm	1,19 mm	1,20 mm

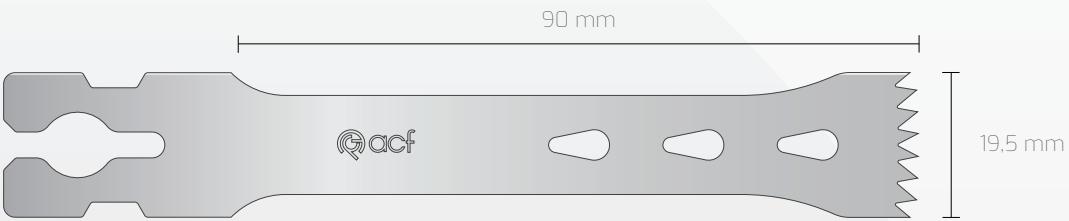

● Non Sterile
 ● Sterile R

Ref	260 195 090 127	260 195 090 130	260 195 090 137	260 195 090 140	260 195 090 147
Thickness	1,27 mm	1,30 mm	1,37 mm	1,40 mm	1,47 mm

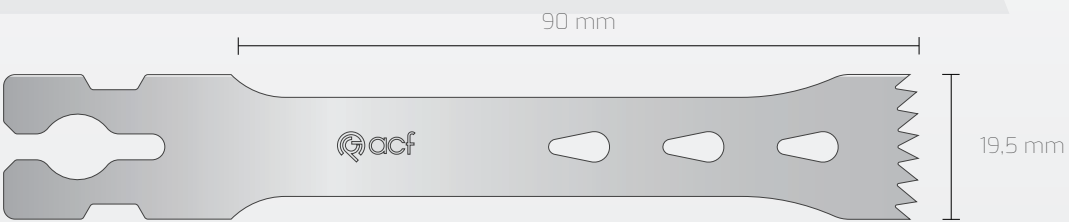

● Non Sterile
 ● Sterile R

Ref 260 195 090 150
 Thickness 1,50 mm

Brasseler® / Tava®

Compatible Connections;
All Brasseler® and Tava®
Sagittal/Oscillator Saw Systems

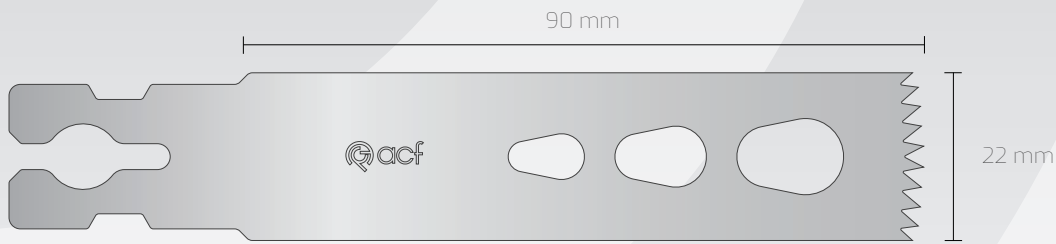

● Non Sterile
● Sterile R

Ref	260 220 090 089	260 220 090 090	260 220 090 100	260 220 090 119	260 220 090 120
Thickness	0,89 mm	0,90 mm	1,00 mm	1,19 mm	1,20 mm

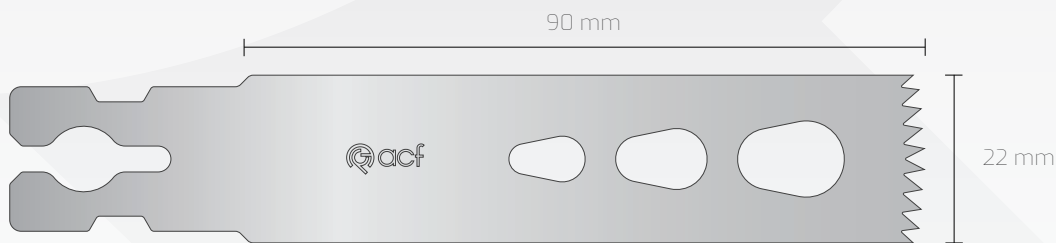

● Non Sterile
● Sterile R

Ref	260 220 090 127	260 220 090 130	260 220 090 137	260 220 090 140	260 220 090 147
Thickness	1,27 mm	1,30 mm	1,37 mm	1,40 mm	1,47 mm

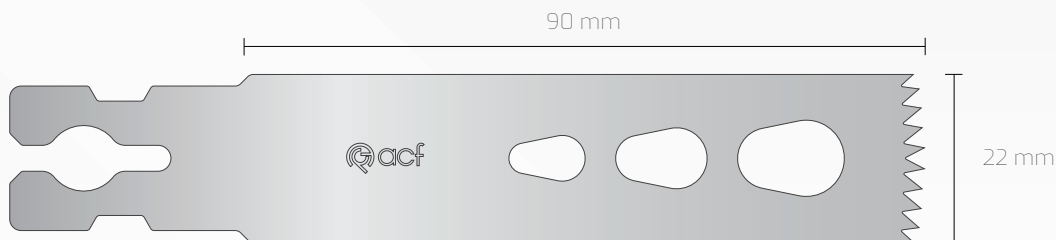

● Non Sterile
● Sterile R

Ref	260 220 090 150
Thickness	1,50 mm

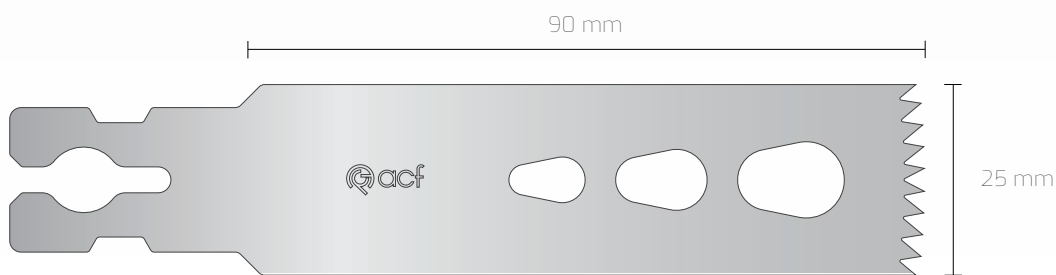

● Non Sterile
● Sterile R

Ref	260 250 090 089	260 250 090 090	260 250 090 100	260 250 090 119	260 250 090 120
Thickness	0,89 mm	0,90 mm	1,00 mm	1,19 mm	1,20 mm

BRASSELER® / TAVA®

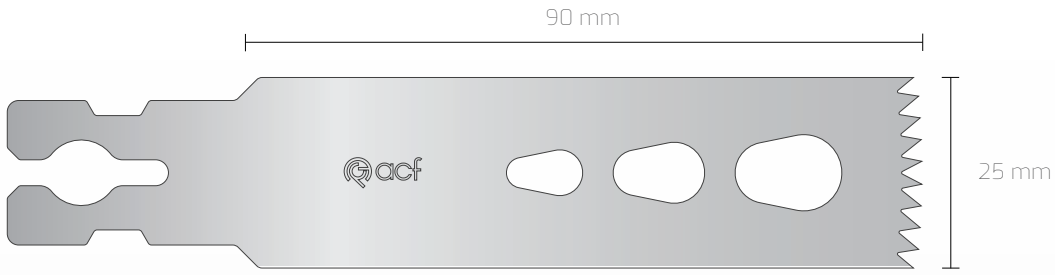

● Non Sterile
 ● Sterile R

Ref	260 250 090 127	260 250 090 130	260 250 090 137	260 250 090 140	260 250 090 147
Thickness	1,27 mm	1,30 mm	1,37 mm	1,40 mm	1,47 mm

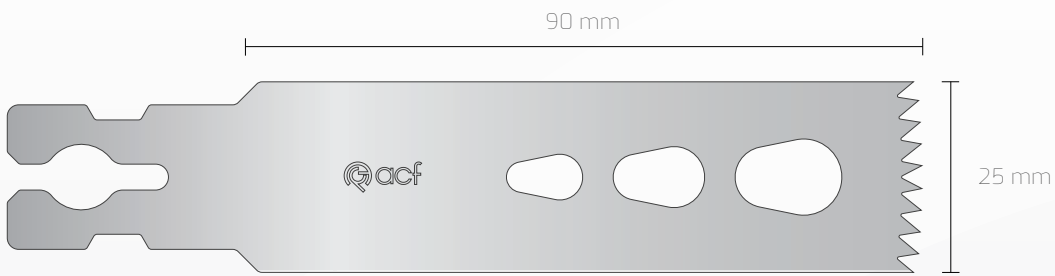

● Non Sterile
 ● Sterile R

Ref	260 250 090 150
Thickness	1,50 mm

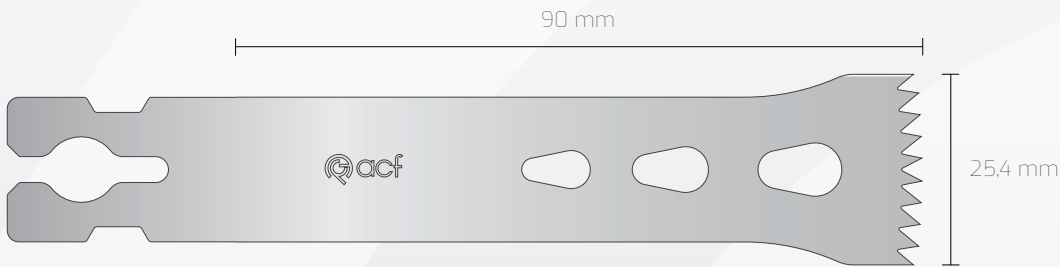

● Non Sterile
 ● Sterile R

Ref	260 254 090 089	260 254 090 090	260 254 090 100	260 254 090 119	260 254 090 120
Thickness	0,89 mm	0,90 mm	1,00 mm	1,19 mm	1,20 mm

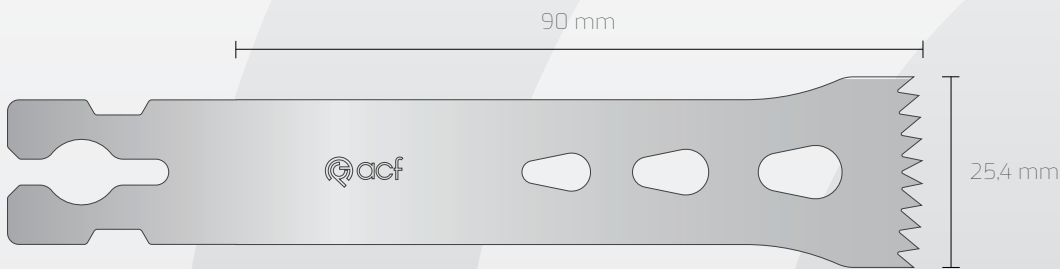

● Non Sterile
 ● Sterile R

Ref	260 254 090 127	260 254 090 130	260 254 090 137	260 254 090 140	260 254 090 147
Thickness	1,27 mm	1,30 mm	1,37 mm	1,40 mm	1,47 mm

Brasseler® / Tava®

Compatible Connections;
All Brasseler® and Tava®
Sagittal/Oscillator Saw Systems

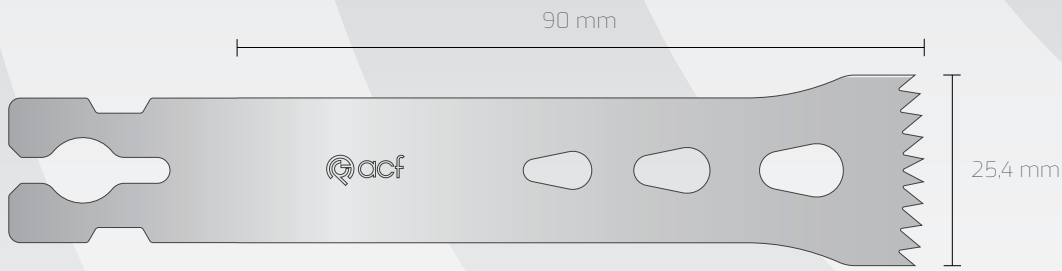

● Non Sterile
● Sterile R

Ref 260 254 090 150

Thickness 1,50 mm

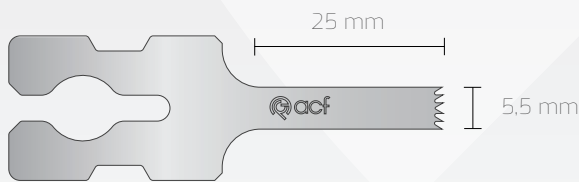

● Non Sterile
● Sterile R

Ref 260 055 025 060

Thickness 0,60 mm

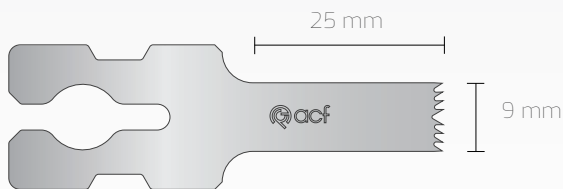

● Non Sterile
● Sterile R

Ref 260 090 025 060

Thickness 0,60 mm

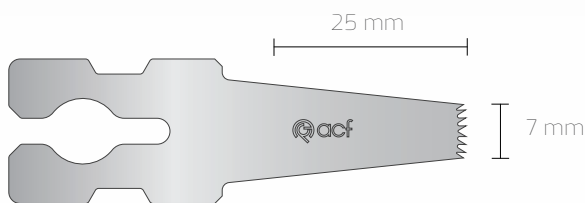

● Non Sterile
● Sterile R

Ref 260 070 025 060

Thickness 0,60 mm

BRASSELER® / TAVA®

● Non Sterile
 ● Sterile R

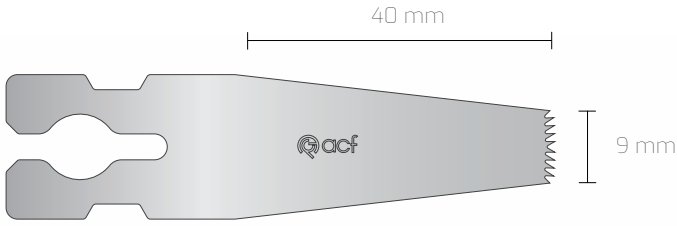

Ref 260 090 040 060
 Thickness 0,60 mm

● Non Sterile
 ● Sterile R

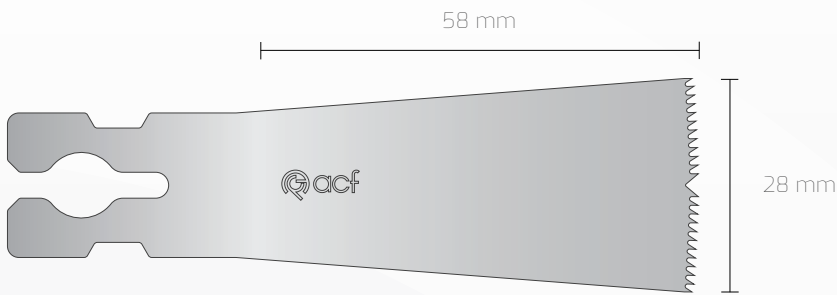

Ref 260 280 058 060
 Thickness 0,60 mm

● Non Sterile
 ● Sterile R

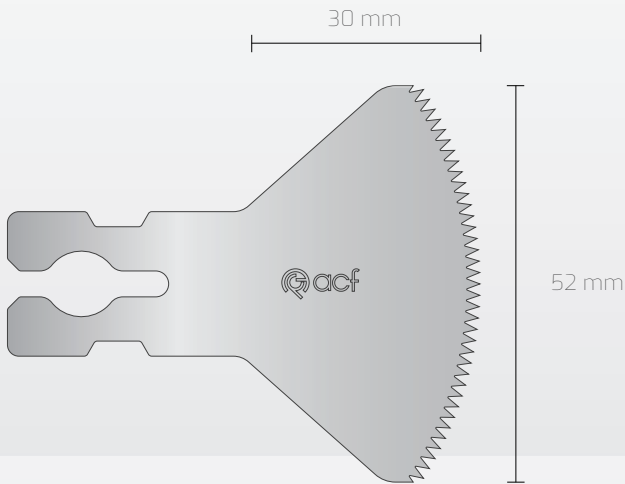

Ref	260 520 030 060	260 520 030 090
Thickness	0,60 mm	0,90 mm

Brasseler® / Tava®

Compatible Connections;
All Brasseler® and Tava®
Sagittal/Oscillator Saw Systems

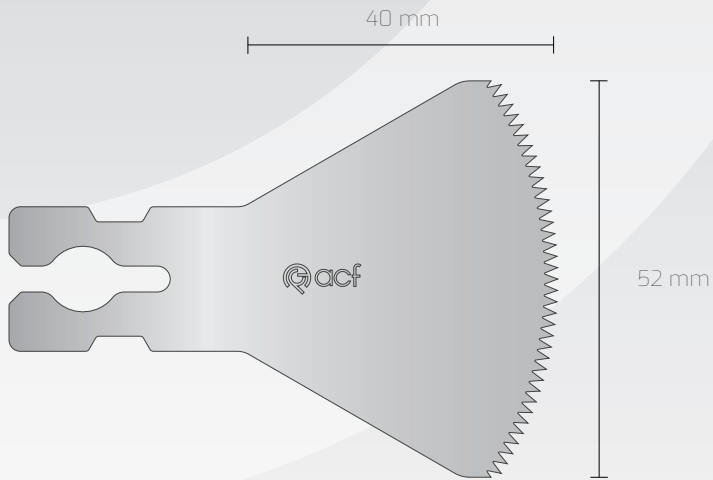

- Non Sterile
- Sterile R

Ref	260 520 040 060	260 520 040 090
Thickness	0,60 mm	0,90 mm

BRASSELER® / TAVA®



ACF Medikal Urunler Mak. San. ve Tic. Ltd. Sti.

Guzelyurt Mah. 5754 Sok. No: 3/A
Yunusemre / Manisa, Turkey, 45030

+90 236 236 28 20

info@acf.com.tr

www.acf.com.tr



ACF.MR.03.EN.R07 20.09.2021