

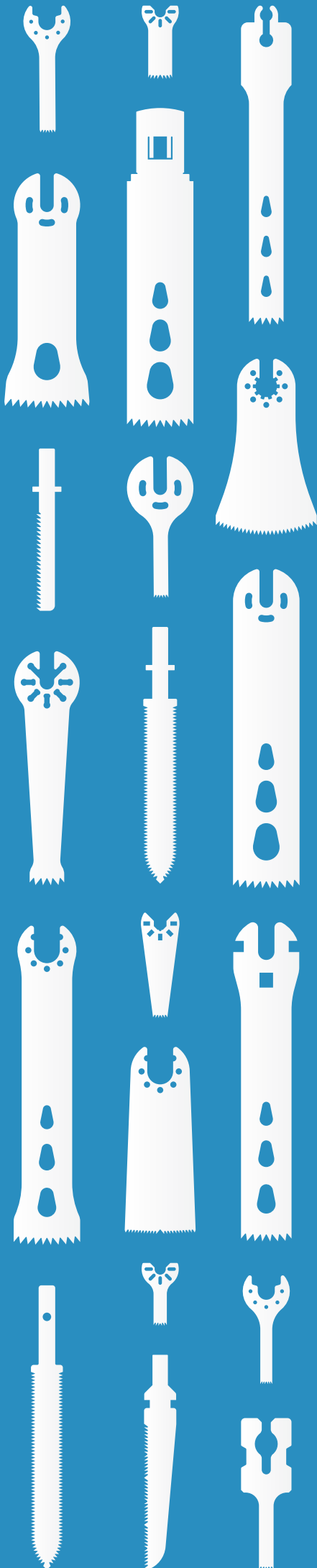

Durable.
Stylish.
That's All You Need.

Surgical Saw Blades

Product Catalog





Saw Blades
Compatible with
ACF[®]



Brand Code **360**

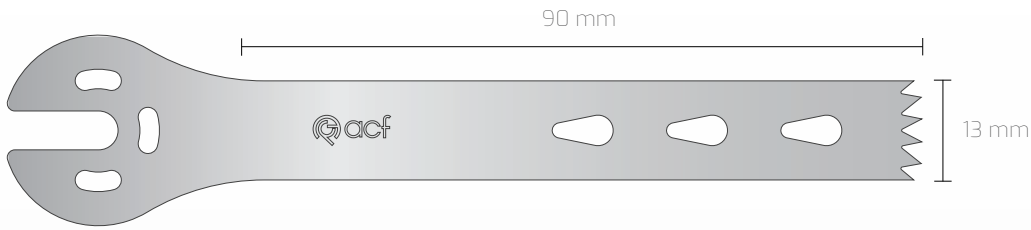

● Non Sterile
 ● Sterile R

Ref	360 130 090 089	360 130 090 090	360 130 090 100	360 130 090 119	360 130 090 120
Thickness	0,89 mm	0,90 mm	1,00 mm	1,19 mm	1,20 mm

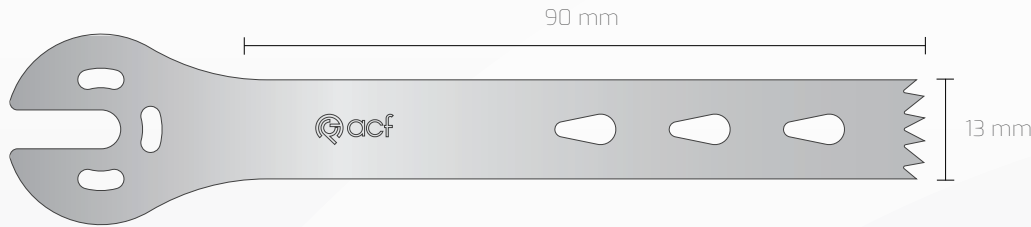

● Non Sterile
 ● Sterile R

Ref	360 130 090 127	360 130 090 130	360 130 090 137	360 130 090 140	360 130 090 147
Thickness	1,27 mm	1,30 mm	1,37 mm	1,40 mm	1,47 mm

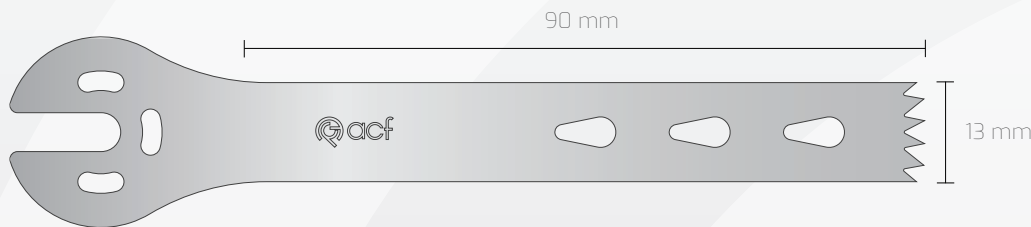

● Non Sterile
 ● Sterile R

Ref	360 130 090 150
Thickness	1,50 mm

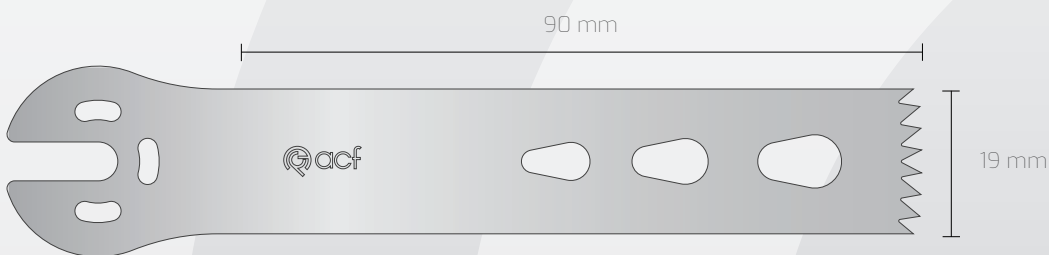

● Non Sterile
 ● Sterile R

Ref	360 190 090 089	360 190 090 090	360 190 090 100	360 190 090 119	360 190 090 120
Thickness	0,89 mm	0,90 mm	1,00 mm	1,19 mm	1,20 mm

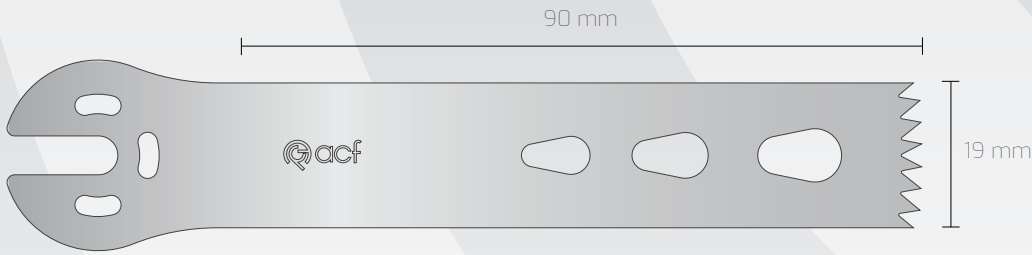

● Non Sterile
● Sterile R

Ref	360 190 090 127	360 190 090 130	360 190 090 137	360 190 090 140	360 190 090 147
Thickness	1,27 mm	1,30 mm	1,37 mm	1,40 mm	1,47 mm

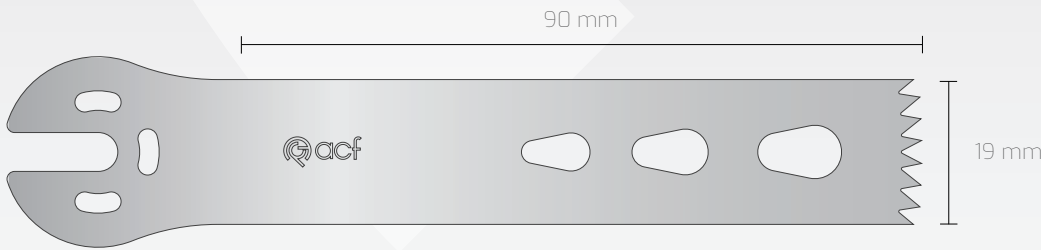

● Non Sterile
● Sterile R

Ref	360 190 090 150
Thickness	1,50 mm

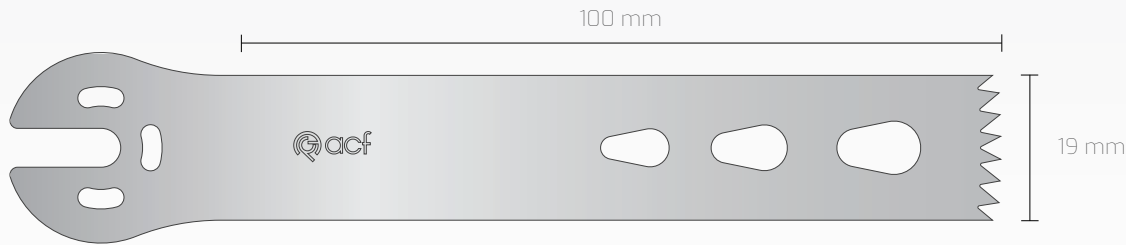

● Non Sterile
● Sterile R

Ref	360 190 100 089	360 190 100 090	360 190 100 100	360 190 100 119	360 190 100 120
Thickness	0,89 mm	0,90 mm	1,00 mm	1,19 mm	1,20 mm

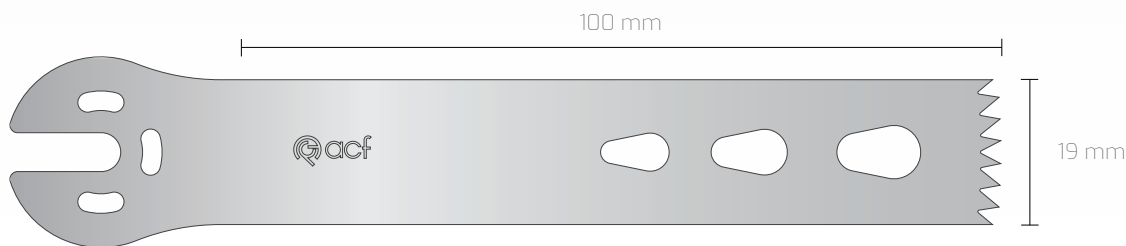

● Non Sterile
● Sterile R

Ref	360 190 100 127	360 190 100 130	360 190 100 137	360 190 100 140	360 190 100 147
Thickness	1,27 mm	1,30 mm	1,37 mm	1,40 mm	1,47 mm

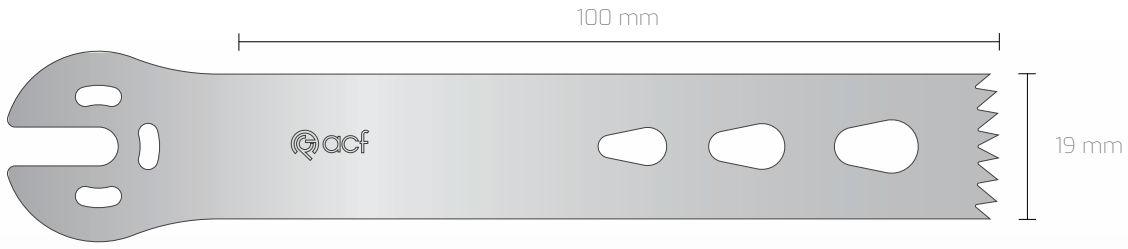

● Non Sterile
 ● Sterile R

Ref 360 190 100 150
Thickness 1,50 mm

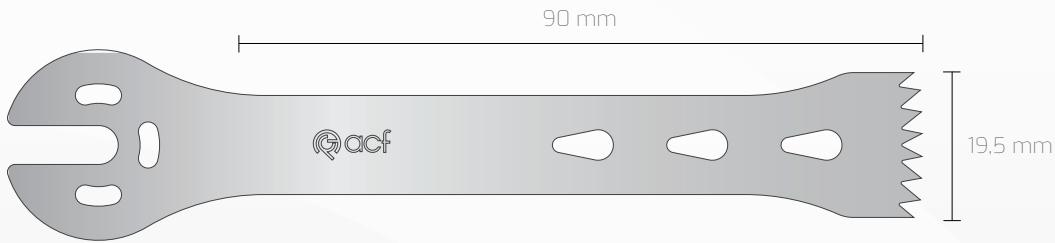

● Non Sterile
 ● Sterile R

Ref	360 195 090 089	360 195 090 090	360 195 090 100	360 195 090 119	360 195 090 120
Thickness	0,89 mm	0,90 mm	1,00 mm	1,19 mm	1,20 mm

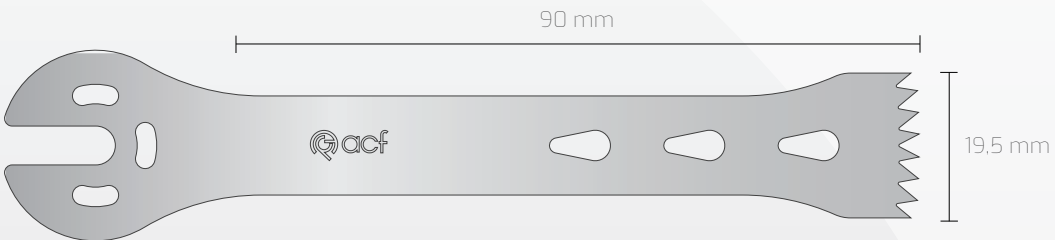

● Non Sterile
 ● Sterile R

Ref	360 195 090 127	360 195 090 130	360 195 090 137	360 195 090 140	360 195 090 147
Thickness	1,27 mm	1,30 mm	1,37 mm	1,40 mm	1,47 mm

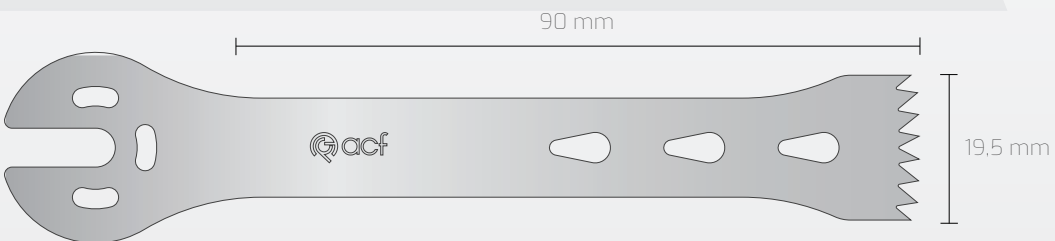

● Non Sterile
 ● Sterile R

Ref 360 195 090 150
Thickness 1,50 mm

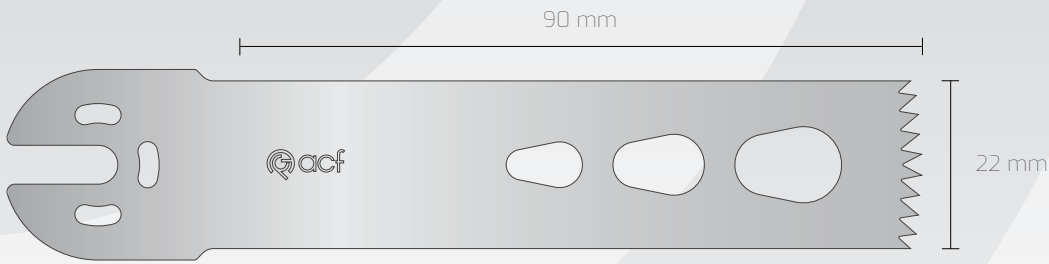

● Non Sterile
● Sterile R

Ref	360 220 090 089	360 220 090 090	360 220 090 100	360 220 090 119	360 220 090 120
Thickness	0,89 mm	0,90 mm	1,00 mm	1,19 mm	1,20 mm

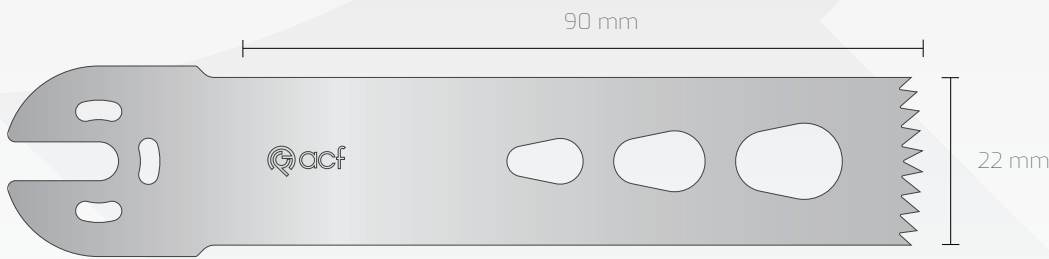

● Non Sterile
● Sterile R

Ref	360 220 090 127	360 220 090 130	360 220 090 137	360 220 090 140	360 220 090 147
Thickness	1,27 mm	1,30 mm	1,37 mm	1,40 mm	1,47 mm

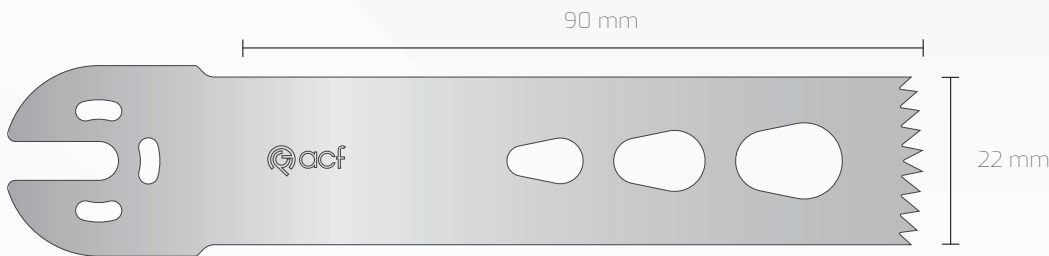

● Non Sterile
● Sterile R

Ref	360 220 090 150
Thickness	1,50 mm

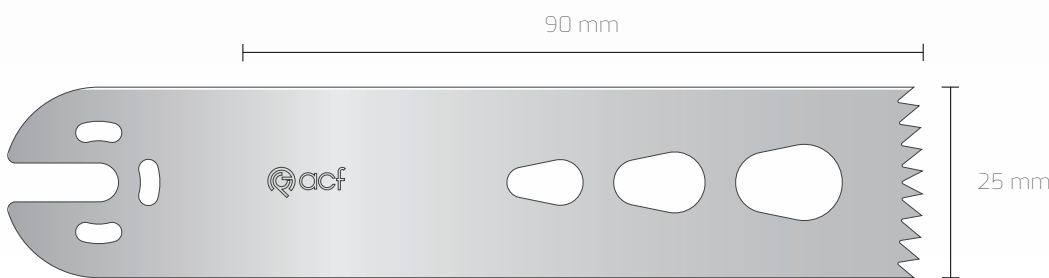

● Non Sterile
● Sterile R

Ref	360 250 090 089	360 250 090 090	360 250 090 100	360 250 090 119	360 250 090 120
Thickness	0,89 mm	0,90 mm	1,00 mm	1,19 mm	1,20 mm

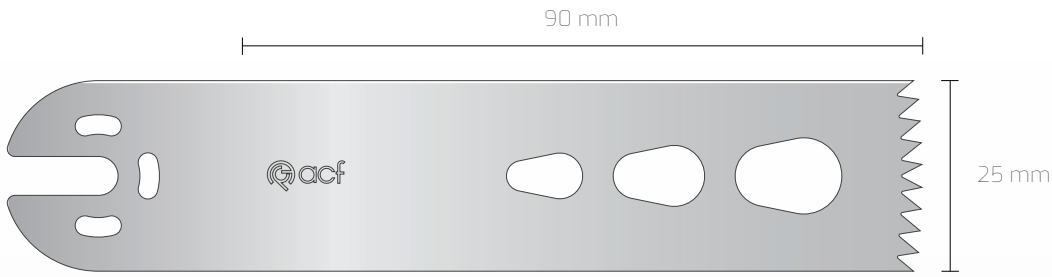

● Non Sterile
 ● Sterile R

Ref	360 250 090 127	360 250 090 130	360 250 090 137	360 250 090 140	360 250 090 147
Thickness	1,27 mm	1,30 mm	1,37 mm	1,40 mm	1,47 mm

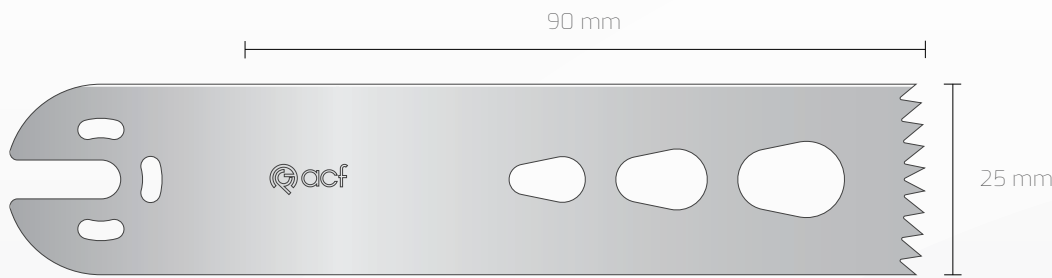

● Non Sterile
 ● Sterile R

Ref	360 250 090 150
Thickness	1,50 mm

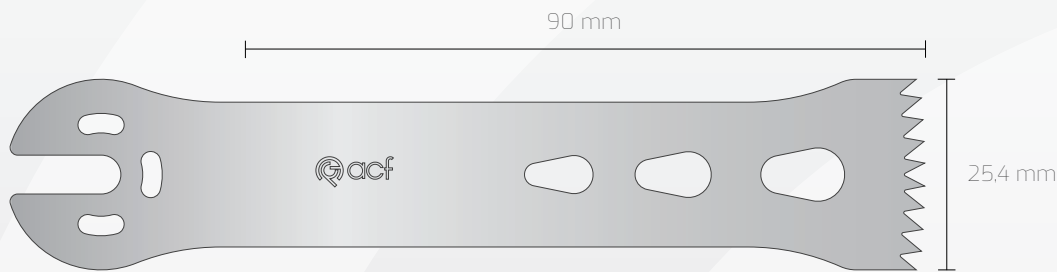

● Non Sterile
 ● Sterile R

Ref	360 254 090 089	360 254 090 090	360 254 090 100	360 254 090 119	360 254 090 120
Thickness	0,89 mm	0,90 mm	1,00 mm	1,19 mm	1,20 mm

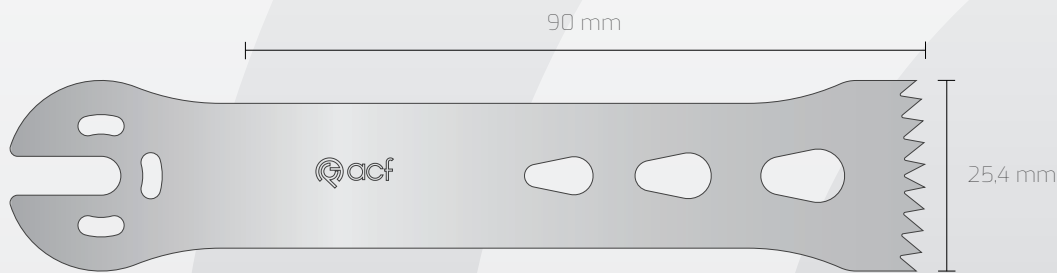

● Non Sterile
 ● Sterile R

Ref	360 254 090 127	360 254 090 130	360 254 090 137	360 254 090 140	360 254 090 147
Thickness	1,27 mm	1,30 mm	1,37 mm	1,40 mm	1,47 mm

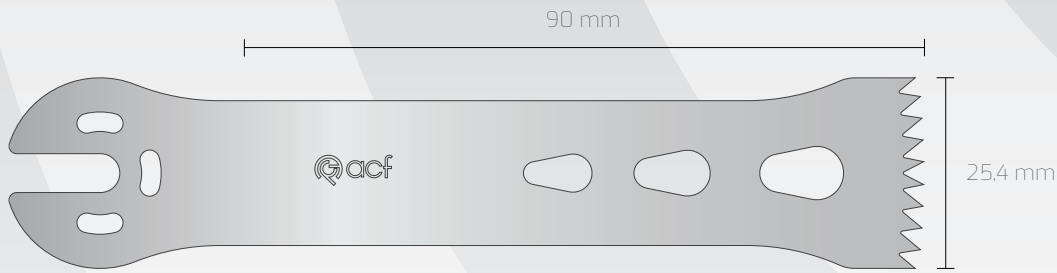

● Non Sterile
● Sterile R

Ref 360 254 090 150
Thickness 1,50 mm



● Non Sterile
● Sterile R

Ref 360 055 025 060
Thickness 0,60 mm



● Non Sterile
● Sterile R

Ref 360 090 025 060
Thickness 0,60 mm

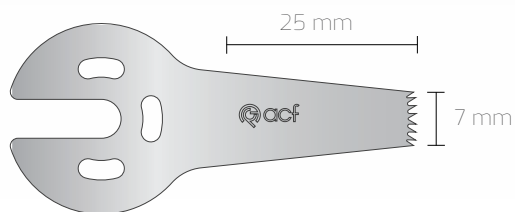

● Non Sterile
● Sterile R

Ref 360 070 025 060
Thickness 0,60 mm

● Non Sterile
● Sterile R

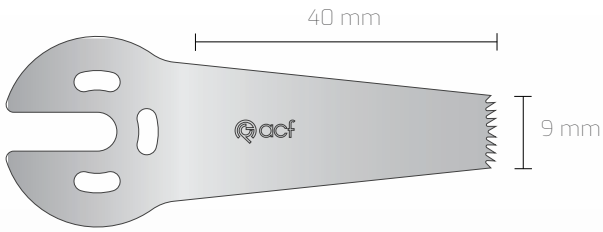

Ref 360 090 040 060
Thickness 0,60 mm

● Non Sterile
● Sterile R

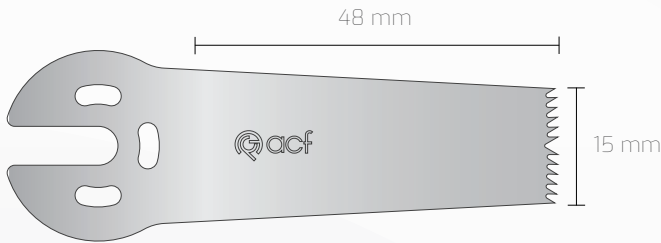

Ref 360 150 048 060
Thickness 0,60 mm

● Non Sterile
● Sterile R

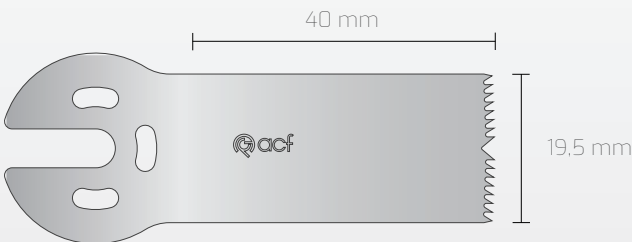

Ref 360 195 040 060
Thickness 0,60 mm

● Non Sterile
● Sterile R

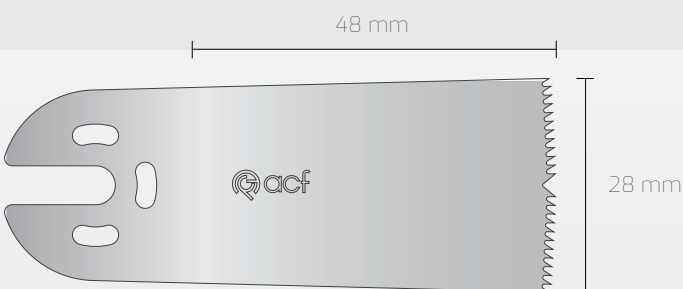

Ref 360 280 048 060
Thickness 0,60 mm

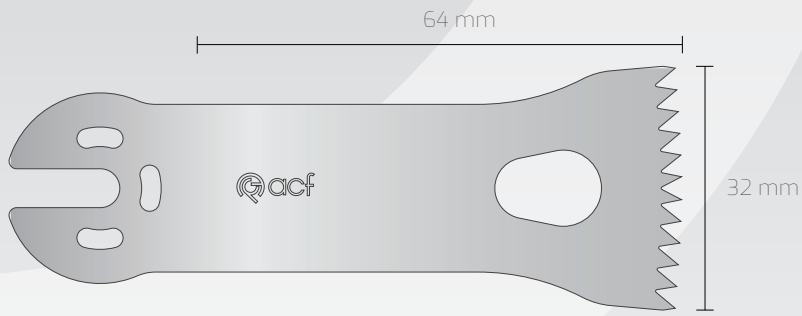

● Non Sterile
● Sterile R

Ref 360 320 064 090
Thickness 0,90 mm

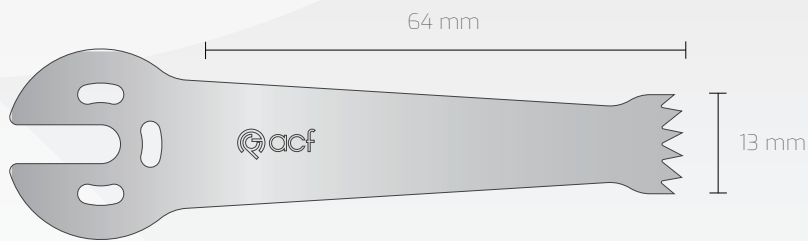

● Non Sterile
● Sterile R

Ref 360 130 064 090
Thickness 0,90 mm

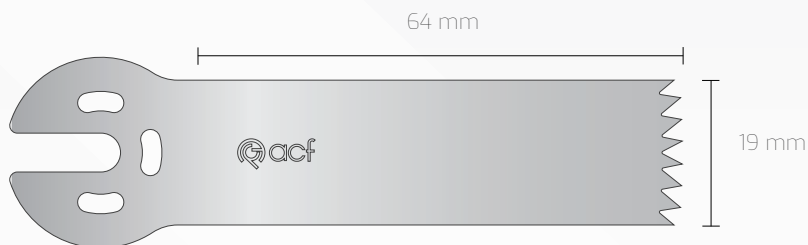

● Non Sterile
● Sterile R

Ref 360 190 064 090
Thickness 0,90 mm

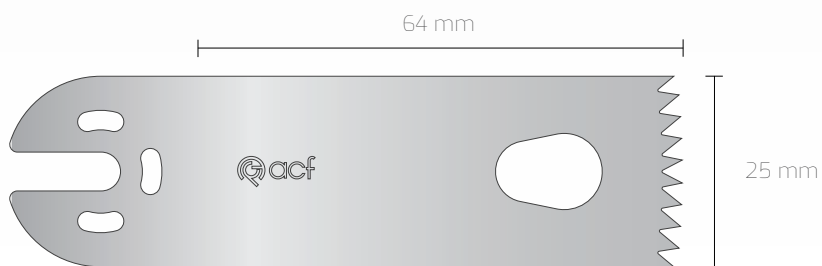

● Non Sterile
● Sterile R

Ref 360 250 064 090
Thickness 0,90 mm

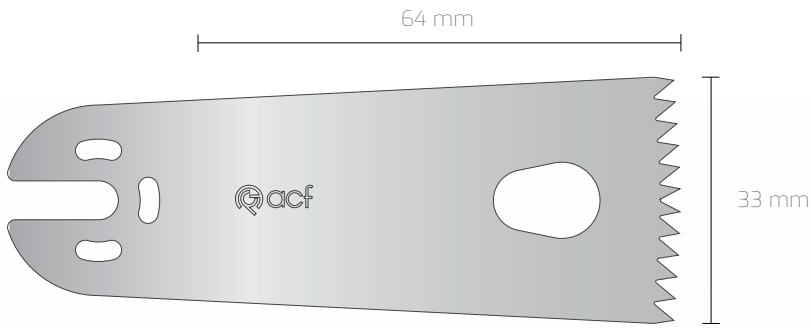

● Non Sterile
● Sterile R

Ref 360 330 064 090
Thickness 0,90 mm

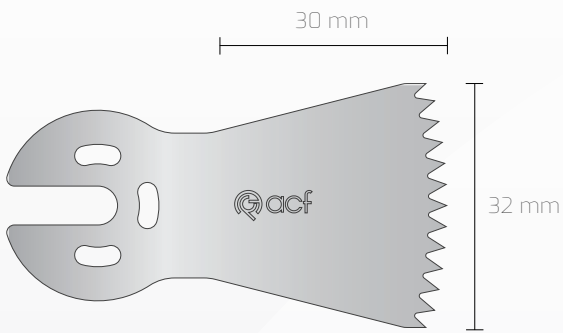

● Non Sterile
● Sterile R

Ref 360 320 030 090
Thickness 0,90 mm

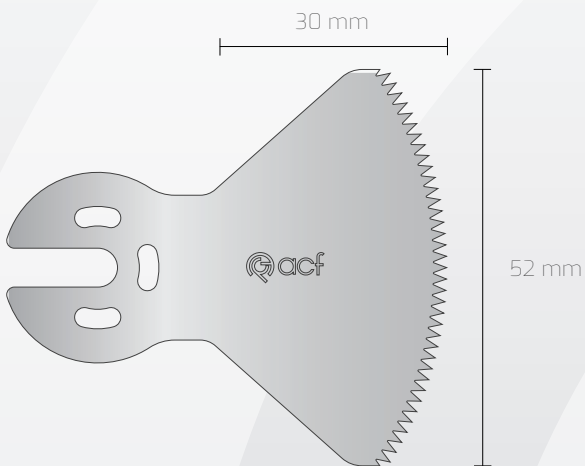

● Non Sterile
● Sterile R

Ref	360 520 030 060	360 520 030 090
Thickness	0,60 mm	0,90 mm

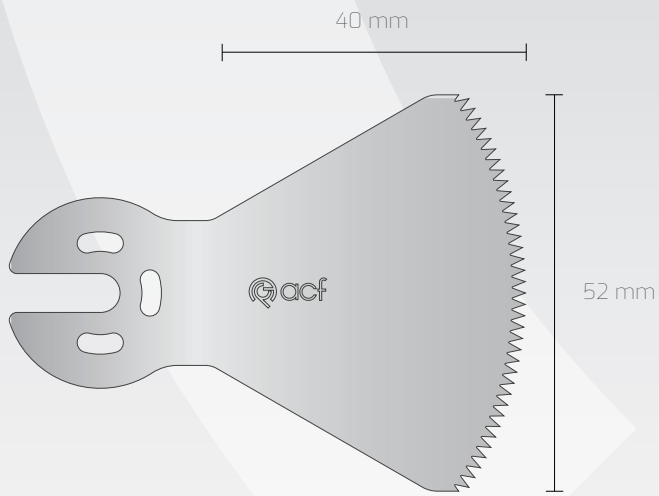

- Non Sterile
- Sterile R

Ref	360 520 040 060	360 520 040 090
Thickness	0,60 mm	0,90 mm



ACF Medikal Urunler Mak. San. ve Tic. Ltd. Sti.

Guzelyurt Mah. 5754 Sok. No: 3/A
Yunusemre / Manisa, Turkey, 45030

+90 236 236 28 20

info@acf.com.tr

www.acf.com.tr



ACF.MR.03.EN.R07 20.09.2021